

The Atlas Copco logo, consisting of the company name in a white serif font, is centered within a blue rectangular box. The box is flanked by two horizontal white bars, one above and one below the text.

Atlas Copco

A technical drawing of a compressor component is overlaid on a blue triangular background in the bottom-left corner. The drawing includes various dimensions and labels such as 'CC (1.3)', 'Ø72', 'Ø78.8', 'Ø76', '1.10.5', '30.8', '1.10.5', and '41.8'.

Atlas Copco Compressed Air Manual

9th edition

COMPRESSED AIR MANUAL

9th edition

The Atlas Copco logo consists of the company name in a blue, italicized serif font, centered between two horizontal blue bars.

Atlas Copco

**This Manual is published by:
Atlas Copco Airpower NV
Boomsesteenweg 957
B-2610 Wilrijk
Belgium**

Reproduction of the contents of this publication, fully or in part, is forbidden in accordance with copyright laws without prior written permission from Atlas Copco Airpower NV. This applies to any form of reproduction through printing, duplication, photocopying, recording, etc.

During the production of this material we have gratefully received pictures and contributions from our customers and suppliers, of which we would especially like to name: ABB, Siemens, Vattenfall and AGA.

Atlas Copco Airpower NV

ISBN: 9789081535809

© Atlas Copco Airpower NV, Belgium, 2019

WELCOME!

This manual offers a comprehensive guidance to anyone who is looking forward to further explore and get insights in compressed air technology. Whether you are a business person, manufacturing expert, scientist, university student or technical consultant, we believe that the knowledge collected in the manual will prove very useful to you. The compressed air manual is unique of its kind and has been widely used and hugely appreciated by many thousands of interested readers over the years. We are proud to present the ninth edition of the manual, several decades after the very first manual was introduced.

A lot of the information in the manual has been gathered around the world and over many years by a number of leading compressed air technology engineers from Atlas Copco. By sharing their knowledge with you, we want to ensure that efficiency gains can be realized faster and better throughout the many industries that depend on compressed air.

As we all know, there will always be room for new technical improvements and better ways of doing things. Our mission at Atlas Copco is to continuously deliver superior sustainable productivity through safer, cleaner, more energy-efficient cost effective compressed air solutions. To accomplish this, we depend on the voice of our customers. We are very grateful for any suggestions or comments that you might have which can help to make this manual even more complete.

We wish you interesting readings and success with your compressed air applications. And ... don't forget to check out our interactive compressed air wiki, a compilation of our in-house knowledge and the compressed air manual.

<https://www.atlascopco.com/en-uk/compressors/wiki>

We welcome your feedback
compressedair@be.atlascopco.com

1 THEORY

1.1 PHYSICS 10

- 1.1.1 The structure of matter 10
- 1.1.2 The molecule and the different states of matter 10

1.2 PHYSICAL UNITS 11

- 1.2.1 Pressure 11
- 1.2.2 Temperature 11
- 1.2.3 Thermal capacity 11
- 1.2.4 Work 13
- 1.2.5 Power 13
- 1.2.6 Volume rate of flow 13

1.3 THERMODYNAMICS 13

- 1.3.1 Main principles 13
- 1.3.2 Gas laws 14
- 1.3.3 Heat transfer 14
- 1.3.4 Changes in state 16
 - 1.3.4.1 Isochoric process 16
 - 1.3.4.2 Isobaric process 16
 - 1.3.4.3 Isothermal process 17
 - 1.3.4.4 Isentropic process 17
 - 1.3.4.5 Polytropic process 17
- 1.3.5 Gas flow through a nozzle 18
- 1.3.6 Flow through pipes 18
- 1.3.7 Throttling 18

1.4 AIR 19

- 1.4.1 Air in general 19
- 1.4.2 Moist air 19

1.5 TYPES OF COMPRESSORS 20

- 1.5.1 Two basic principles 20
- 1.5.2 Positive displacement compressors 20
- 1.5.3 The compressor diagram for displacement compressors 20
- 1.5.4 Dynamic compressors 22
- 1.5.5 Compression in several stages 23
- 1.5.6 Comparison: turbocompressor and positive displacement 23

1.6 ELECTRICITY 24

- 1.6.1 Basic terminology and definitions 24
- 1.6.2 Ohm's law for alternating current 24
- 1.6.3 Three-phase system 25
- 1.6.4 Power 25
- 1.6.5 The electric motor 27
 - 1.6.5.1 Rotation speed 27
 - 1.6.5.2 Efficiency 27

- 1.6.5.3 Insulation class 27
- 1.6.5.4 Protection classes 27
- 1.6.5.5 Cooling methods 27
- 1.6.5.6 Installation method 28
- 1.6.5.7 Star (Y) and delta (Δ) connections 28
- 1.6.5.8 Torque 29

2 COMPRESSORS AND AUXILIARY EQUIPMENT

2.1 DISPLACEMENT COMPRESSORS 32

- 2.1.1 Displacement compressors 32
- 2.1.2 Piston compressors 32
- 2.1.3 Oil-free piston compressors 32
- 2.1.4 Diaphragm compressor 34
- 2.1.5 Twin screw compressors 34
 - 2.1.5.1 Oil-free screw compressors 34
 - 2.1.5.2 Liquid-injected screw compressors 37
- 2.1.6 Tooth compressors 37
- 2.1.7 Scroll compressors 38
- 2.1.8 Vane compressors 40
- 2.1.9 Roots blowers 40

2.2 DYNAMIC COMPRESSORS 41

- 2.2.1 Dynamic compressors in general 41
- 2.2.2 Centrifugal compressors 41
- 2.2.3 Axial compressors 43

2.3 OTHER COMPRESSORS 43

- 2.3.1 Vacuum pumps 43
- 2.3.2 Booster compressors 43
- 2.3.3 Pressure intensifiers 44

2.4 TREATMENT OF COMPRESSED AIR 44

- 2.4.1 Drying compressed air 44
 - 2.4.1.1 After-cooler 45
 - 2.4.1.2 Refrigerant dryer 46
 - 2.4.1.3 Over-compression 47
 - 2.4.1.4 Absorption drying 47
 - 2.4.1.5 Adsorption drying 47
 - 2.4.1.6 Membrane dryers 50
- 2.4.2 Filters 50

2.5 CONTROL AND REGULATION SYSTEMS 52

- 2.5.1 Regulation in general 52
- 2.5.2 Regulation principles for displacement compressors 53
 - 2.5.2.1 Pressure relief 53
 - 2.5.2.2 Bypass 54
 - 2.5.2.3 Throttling the inlet 54
 - 2.5.2.4 Pressure relief with throttled inlet 54

2.5.2.5 Start/stop	54
2.5.2.6 Speed regulation	54
2.5.2.7 Variable discharge port	55
2.5.2.8 Suction valve unloading	55
2.5.2.9 Load–unload–stop	55
2.5.3 Regulation principles for dynamic compressors	56
2.5.3.1 Inlet regulation	56
2.5.3.2 Outlet regulation	56
2.5.3.3 Load–unload–stop	56
2.5.3.4 Speed regulation	56
2.5.4 Control and monitoring	57
2.5.4.1 General	57
2.5.4.2 Load–unload–stop	57
2.5.4.3 Speed control	58
2.5.5 Data monitoring	58
2.5.5.1 Temperature measurement	58
2.5.5.2 Pressure measurement	58
2.5.5.3 Monitoring	59
2.5.6 Comprehensive control system	60
2.5.6.1 Start sequence selector	60
2.5.7 Central control	61
2.5.8 Remote monitoring	61
2.6 MOBILE COMPRESSORS	63
2.6.1 General	63
2.6.2 Noise level and exhaust emissions	63
2.6.3 Operational flexibility	64

3 DIMENSIONING AND SERVICING COMPRESSOR INSTALLATIONS

3.1 DIMENSIONING COMPRESSOR INSTALLATIONS	66
3.1.1 General	66
3.1.1.1 Calculating the working pressure	66
3.1.1.2 Calculating the air requirement	67
3.1.1.3 Measuring the air requirement	68
3.1.2 Centralization or decentralization	69
3.1.2.1 General	69
3.1.2.2 Centralized compressor installations	69
3.1.2.3 Decentralized compressor installations	69
3.1.3 Dimensioning at high altitude	69
3.1.3.1 General	69
3.1.3.2 The effect on a compressor	70
3.1.3.3 Power source	71
3.1.3.3.1 Dimensioning electric motors	71
3.1.3.3.2 Dimensioning IC engines	71

3.2 AIR TREATMENT	72
3.2.1 General	72
3.2.2 Water vapor in compressed air	72
3.2.3 Oil in compressed air	73
3.2.4 Micro-organisms in compressed air	74
3.2.5 Filters	74
3.2.6 After-cooler	75
3.2.7 Water separator	75
3.2.8 Oil / water separation	75
3.2.9 Medical air	76
3.3 COOLING SYSTEM	77
3.3.1 Water-cooled compressors	77
3.3.1.1 General	77
3.3.1.2 Open system without circulating water	77
3.3.1.3 Open system with circulating water	77
3.3.1.4 Closed system	78
3.3.2 Air cooled compressors	78
3.4 ENERGY RECOVERY	79
3.4.1 General	79
3.4.2 Calculation of the recovery potential	81
3.4.3 Recovery methods	82
3.4.3.1 General	82
3.4.3.2 Air-cooled system	82
3.4.3.3 Water-cooled system	82
3.5 THE COMPRESSOR ROOM	84
3.5.1 General	84
3.5.2 Placement and design	85
3.5.3 Foundation	85
3.5.4 Intake air	85
3.5.5 Compressor room ventilation	86
3.5.6 Air Vessel Safety	89
3.6 COMPRESSED AIR DISTRIBUTION	90
3.6.1 General	90
3.6.1.1 Air receiver	90
3.6.2 Design of the compressed air network	91
3.6.3 Dimensioning the compressed air network	91
3.6.4 Flow measurement	94
3.7 ELECTRICAL INSTALLATION	95
3.7.1 General	95
3.7.2 Motors	95
3.7.3 Starting methods	95
3.7.4 Control voltage	96
3.7.5 Short-circuit protection	96
3.7.6 Cables	96
3.7.7 Phase compensation	97

3.8 SOUND	97	5.3 COMPONENT SELECTION	117
3.8.1 General	97	5.3.1 Dimensioning the compressor	117
3.8.2 Absorption	98	5.3.2 Final compressor selection	118
3.8.3 Room Constant	98	5.3.3 Dimensioning the air receiver volume	118
3.8.4 Reverberation	98	5.3.4 Dimensioning the dryer	118
3.8.5 Relationship between sound power level and sound pressure level	99	5.3.5 Summary for continued calculation	119
3.8.6 Sound measurements	99	5.3.6 Checking calculations	119
3.8.7 Interaction of several sound sources	100	5.4 ADDITIONAL DIMENSIONING WORK	120
3.8.8 Sound reduction	100	5.4.1 Condensation quantity calculation	120
3.8.9 Noise within compressor installations	101	5.4.2 Ventilation requirement in the compressor room	120
4 ECONOMY		5.5 SPECIAL CASE: HIGH ALTITUDE	121
4.1 COST	104	5.6 SPECIAL CASE: INTERMITTENT OUTPUT	122
4.1.1 Compressed air production cost	104	5.7 SPECIAL CASE: WATERBORNE ENERGY RECOVERY	123
4.1.1.1 General	104	5.7.1 Assumption	123
4.1.1.2 Cost allocation	105	5.7.2 Calculation of the water flow in the energy recovery circuit	124
4.2 OPPORTUNITIES FOR SAVING	105	5.7.3 Energy balance across the recovery heat exchanger	124
4.2.1 Power requirement	105	5.7.4 Summary	124
4.2.2 Working pressure	105	5.8 SPECIAL CASE: PRESSURE DROP IN THE PIPING	125
4.2.3 Air consumption	106	6 APPENDICES	
4.2.4 Regulation method	107	6.1 THE SI SYSTEM	128
4.2.5 Air quality	108	6.2 DRAWING SYMBOLS	130
4.2.6 Energy recovery	109	6.3 DIAGRAMS AND TABLES	132
4.2.7 Maintenance	110	6.4 COMPILATION OF APPLICABLE STANDARDS AND REGULATIONS	137
4.2.7.1 Maintenance planning	110	6.4.1 General	137
4.2.7.2 Auxiliary equipment	111	6.4.2 Standards	137
4.3 LIFE CYCLE COST	111	6.4.3 Compilation	137
4.3.1 General	111	6.4.3.1 Machinery safety	137
4.3.2 LCC calculation	112	6.4.3.2 Pressure equipment safety	137
5 CALCULATION EXAMPLE		6.4.3.3 Environment	138
5.1 EXAMPLE OF DIMENSIONING COMPRESSED AIR INSTALLATIONS	116	6.4.3.4 Electrical safety	138
5.2 INPUT DATA	116	6.4.3.5 Medical devices – general	138
5.2.1 Compressed Air Requirement	116	6.4.3.6 Standardization	138
5.2.2 Ambient conditions for dimensioning	116	6.4.3.7 Specifications and testing	138
5.2.3 Additional specifications	116		

 *CHAPTER 1
THEORY*

 *CHAPTER 2
COMPRESSORS AND
AUXILIARY EQUIPMENT*

 *CHAPTER 3
DIMENSIONING AND
SERVICING COMPRESSOR
INSTALLATIONS*

 *CHAPTER 4
ECONOMY*

 *CHAPTER 5
CALCULATION EXAMPLE*

 *CHAPTER 6
APPENDICES*

1 THEORY

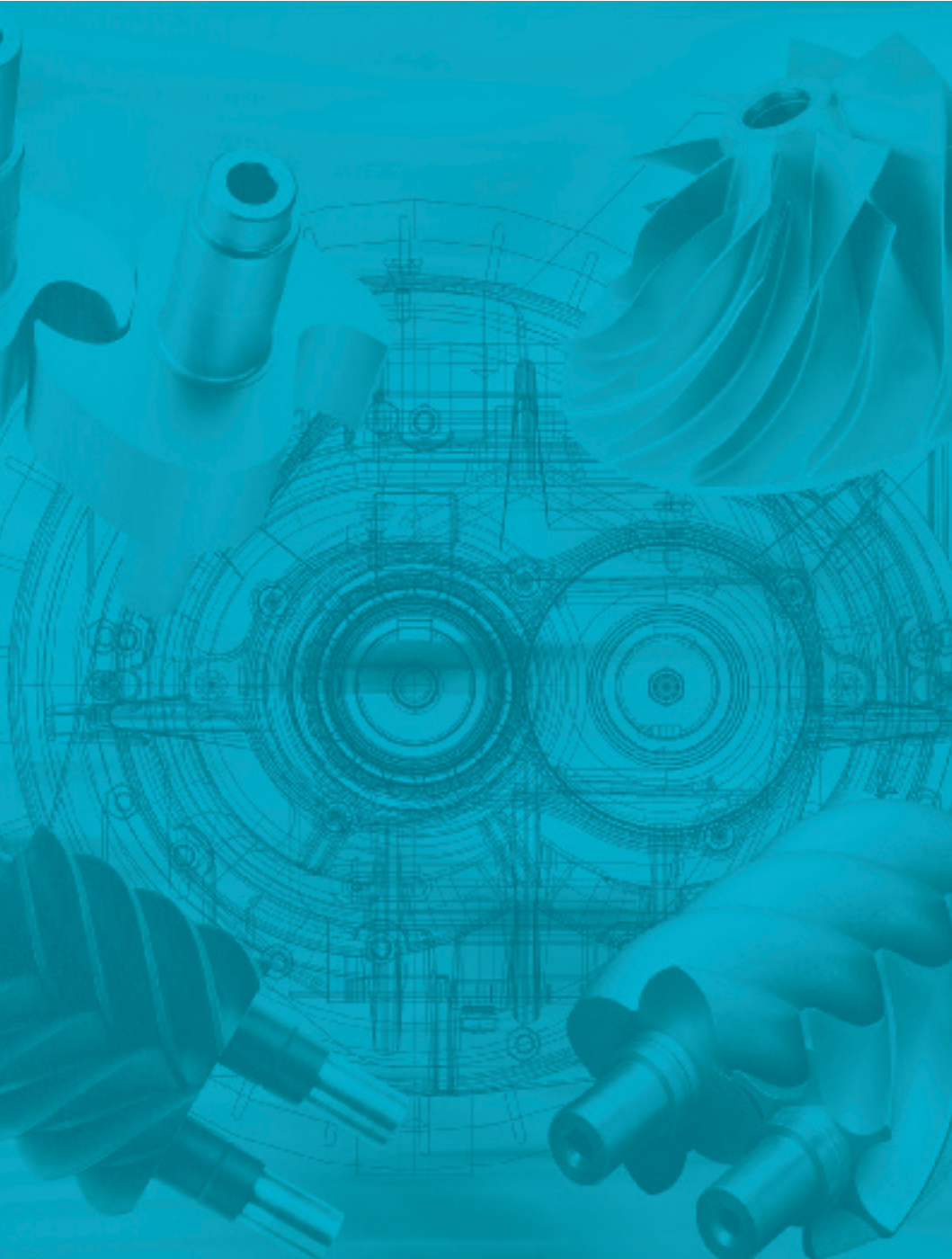

1.1 PHYSICS

1.1.1 The structure of matter

All matter, be it in gaseous, liquid or solid form, is composed of atoms. Atoms are therefore the basic building blocks of matter, though they nearly always appear as part of a molecule. A molecule is a number of atoms grouped together with other atoms of the same or a different kind. Atoms consist of a dense nucleus that is composed of protons and neutrons surrounded by a number of small, lightweight and rapidly-spinning electrons. Other building blocks exist; however, they are not stable. All of these particles are characterized by four properties: their electrical charge, their rest mass, their mechanical momentum and their magnetic momentum. The number of protons in the nucleus is equal to the atom's atomic number.

The total number of protons and the number of neutrons are approximately equal to the atom's

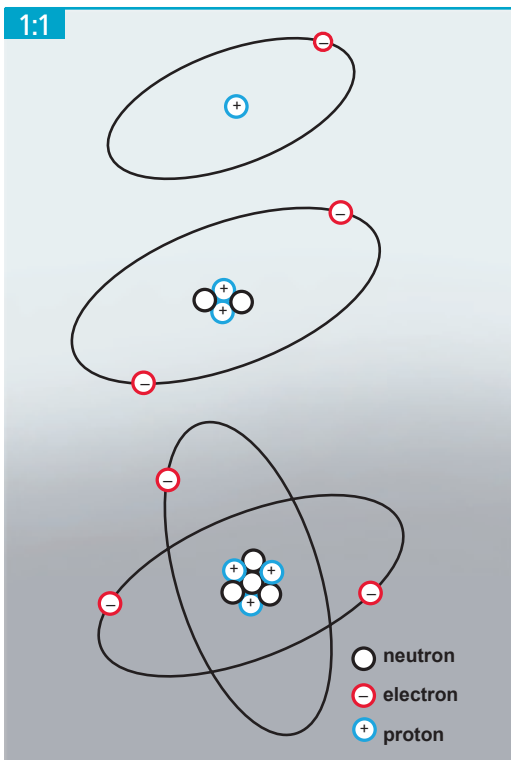

The electron shell gives elements their chemical properties. Hydrogen (top) has one electron in an electron shell. Helium (middle) has two electrons in an electron shell. Lithium (bottom) has a third electron in a second shell.

total mass, since electrons add nearly no mass. This information can be found on the periodic chart. The electron shell contains the same number of electrons as there are protons in the nucleus. This means that an atom is generally electrically neutral.

The Danish physicist, Niels Bohr, introduced a build-up model of an atom in 1913. He demonstrated that atoms can only occur in a so called stationary state and with a determined energy. If the atom transforms from one energy state into another, a radiation quantum is emitted. This is known as a photon.

These different transitions are manifested in the form of light with different wavelengths. In a spectrograph, they appear as lines in the atom's spectrum of lines.

1.1.2 The molecule and the different states of matter

Atoms held together by chemical bonding are called molecules. These are so small that 1 mm³ of air at atmospheric pressure contains approx. 2.55×10^{16} molecules.

In principle, all matter can exist in four different states: the solid state, the liquid state, the gaseous state and the plasma state. In the solid state, the molecules are tightly packed in a lattice structure with strong bonding. At temperatures above absolute zero, some degree of molecular movement occurs. In the solid state, this is as vibration around a balanced position, which

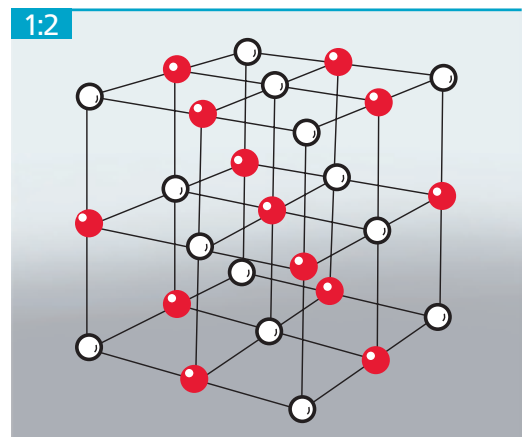

A salt crystal such as common table salt NaCl has a cubic structure. The lines represent the bonding between the sodium (red) and the chlorine (white) atoms.

1.3

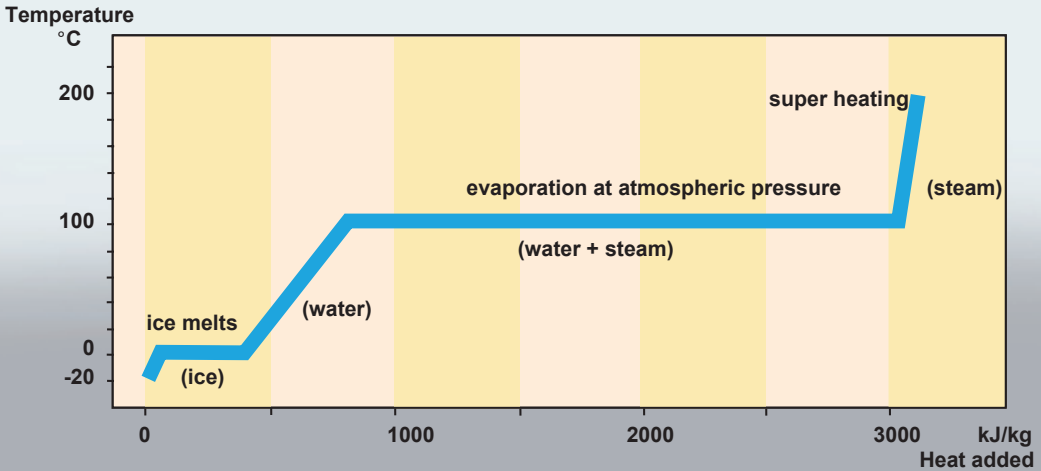

By applying or removing thermal energy the physical state of a substance changes. This curve illustrates the effect for pure water.

becomes faster as the temperature rises. When a substance in a solid state is heated so much that the movement of the molecules cannot be prevented by the rigid lattice pattern, they break loose, the substance melts and it is transformed into a liquid. If the liquid is heated further, the bonding of the molecules is entirely broken, and the liquid substance is transformed into a gaseous state, which expands in all directions and mixes with the other gases in the room.

When gas molecules are cooled, they lose velocity and bond to each other again to produce condensation. However, if the gas molecules are heated further, they are broken down into individual sub-particles and form a plasma of electrons and atomic nuclei.

1.2 PHYSICAL UNITS

1.2.1 Pressure

The force on a square centimeter area of an air column, which runs from sea level to the edge of the atmosphere, is about 10.13 N. Therefore, the absolute atmospheric pressure at sea level is approx. 10.13×10^4 N per square meter, which is equal to 10.13×10^4 Pa (Pascal, the SI unit for pressure). Expressed in another frequently used unit: 1 bar = 1×10^5 Pa. The higher you are above

(or below) sea level, the lower (or higher) the atmospheric pressure.

1.2.2 Temperature

The temperature of a gas is more difficult to define clearly. Temperature is a measure of the kinetic energy in molecules. Molecules move more rapidly the higher the temperature, and movement completely ceases at a temperature of absolute zero. The Kelvin (K) scale is based on this phenomenon, but otherwise is graduated in the same manner as the centigrade or Celsius (C) scale:

$$T = t + 273.2$$

$$T = \text{absolute temperature (K)}$$

$$t = \text{centigrade temperature (C)}$$

1.2.3 Thermal capacity

Heat is a form of energy, represented by the kinetic energy of the disordered molecules of a substance. The thermal capacity (also called heat capacity) of an object refers to the quantity of heat required to produce a unit change of temperature (1K), and is expressed in J/K.

The specific heat or specific thermal capacity of a substance is more commonly used, and refers to the quantity of heat required to produce a unit change of temperature (1K) in a unit mass of substance (1 kg).

1:4

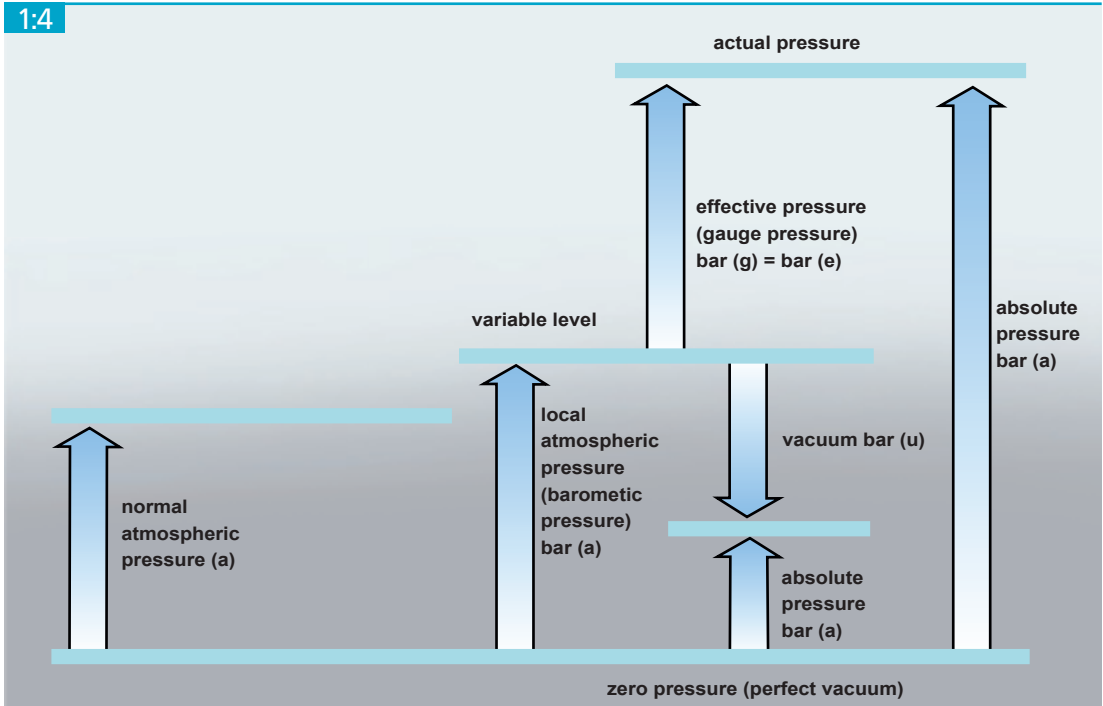

Most pressure gauges register the difference between the pressure in a vessel and the local atmospheric pressure. Therefore to find the absolute pressure the value of the local atmospheric pressure must be added.

1:5

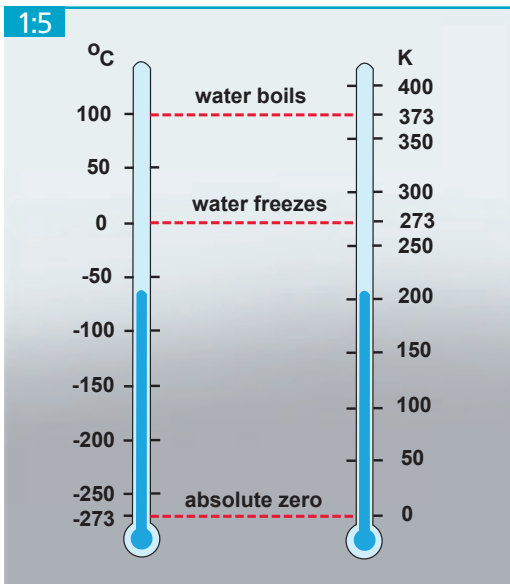

This illustrates the relation between Celsius and Kelvin scales. For the Celsius scale 0° is set at the freezing point of water; for the Kelvin scale 0° is set at absolute zero.

Specific heat is expressed in $\text{J}/(\text{kg} \times \text{K})$. Similarly, the molar heat capacity is dimensioned $\text{J}/(\text{mol} \times \text{K})$.

c_p = specific heat at constant pressure

c_v = specific heat at constant volume

C_p = molar specific heat at constant pressure

C_v = molar specific heat at constant volume

The specific heat at constant pressure is always greater than the specific heat at constant volume. The specific heat for a substance is not a constant, but rises, in general, as the temperature rises.

For practical purposes, a mean value may be used. For liquids and solid substances $c_p \approx c_v \approx c$. To heat a mass flow (\dot{m}) from temperature t_1 to t_2 will then require:

$$P \approx \dot{m} \times c \times (T_2 - T_1)$$

P = heat power (W)

\dot{m} = mass flow (kg/s)

c = specific heat ($\text{J}/\text{kg} \times \text{K}$)

T = temperature (K)

The explanation as to why c_p is greater than c_v is the expansion work that the gas at a constant pressure must perform. The ratio between c_p and c_v is called the isentropic exponent or adiabatic exponent, K , and is a function of the number of atoms in the molecules of the substance.

$$K = \frac{c_p}{c_v} = \frac{C_p}{C_v}$$

1.2.4 Work

Mechanical work may be defined as the product of a force and the distance over which the force operates on a body. Exactly as for heat, work is energy that is transferred from one body to another. The difference is that it is now a matter of force instead of temperature.

An illustration of this is gas in a cylinder being compressed by a moving piston. Compression takes place as a result of a force moving the piston. Energy is thereby transferred from the piston to the enclosed gas. This energy transfer is work in the thermodynamic sense of the word. The result of work can have many forms, such as changes in the potential energy, the kinetic energy or the thermal energy.

The mechanical work associated with changes in the volume of a gas mixture is one of the most important processes in engineering thermodynamics. The SI unit for work is the Joule: $1 \text{ J} = 1 \text{ Nm} = 1 \text{ Ws}$.

1.2.5 Power

Power is work performed per unit of time. It is a measure of how quickly work can be done. The SI unit for power is the Watt: $1 \text{ W} = 1 \text{ J/s}$.

For example, the power or energy flow to a drive shaft on a compressor is numerically similar to the heat emitted from the system plus the heat applied to the compressed gas.

1.2.6 Volume rate of flow

The volumetric flow rate of a system is a measure of the volume of fluid flowing per unit of time. It may be calculated as the product of the cross-sectional area of the flow and the average flow velocity. The SI unit for volume rate of flow is m^3/s .

However, the unit liter/second (l/s) is also frequently used when referring to the volume rate of flow (also called the capacity) of a compressor. It is either stated as Normal liter/second (NI/s) or as free air delivery (l/s).

With NI/s the air flow rate is recalculated to "the normal state", i.e. conventionally chosen as 1.013 bar(a) and 0°C . The Normal unit NI/s is primarily used when specifying a mass flow.

For free air delivery (FAD) the compressor's output flow rate is recalculated to a free air volume rate at the standard inlet condition (inlet pressure 1 bar(a) and inlet temperature 20°C). The relation between the two volume rates of flow is (note that the simplified formula below does not account for humidity):

$$q_{FAD} = q_N \times \frac{T_{FAD}}{T_N} \times \frac{p_N}{p_{FAD}}$$

$$q_{FAD} = q_N \times \frac{(273 + 20)}{273} \times \frac{1.013}{1.00}$$

- q_{FAD} = Free Air Delivery (l/s)
- q_N = Normal volume rate of flow (NI/s)
- T_{FAD} = standard inlet temperature (20°C)
- T_N = Normal reference temperature (0°C)
- p_{FAD} = standard inlet pressure (1.00 bar(a))
- p_N = Normal reference pressure (1.013 bar(a))

1.3 THERMODYNAMICS

1.3.1 Main principles

Energy exists in various forms, such as thermal, physical, chemical, radiant (light etc.) and electrical energy. Thermodynamics is the study of thermal energy, i.e. of the ability to bring about change in a system or to do work.

The first law of thermodynamics expresses the principle of conservation of energy. It says that energy can be neither created nor destroyed, and from this, it follows that the total energy in a closed system is always conserved, thereby remaining constant and merely changing from one form into another. Thus, heat is a form of energy that can be generated from or converted into work.

The second law of Thermodynamics states that there is a tendency in nature to proceed toward a state of greater molecular disorder. Entropy is a measure of disorder: Solid crystals, the most regularly structured form of matter, have very low entropy values. Gases, which are more highly disorganized, have high entropy values.

The potential energy of isolated energy systems that is available to perform work decreases with increasing entropy. The Second Law of Thermodynamics states that heat can never of "its own effort" transfer from a lower-temperature region to a higher temperature region.

1.3.2 Gas laws

Boyle's law states that if the temperature is constant (isotherm), then the product of the pressure and volume are constant. The relation reads:

$$p_1 \times V_1 = p_2 \times V_2$$

p = absolute pressure (Pa)

V = volume (m^3)

This means that if the volume is halved during compression, then the pressure is doubled, provided that the temperature remains constant.

Charles's law says that at constant pressure (isobar), the volume of a gas changes in direct proportion to the change in temperature. The relation reads:

$$\frac{V_1}{T_1} = \frac{V_2}{T_2}$$

V = volume (m^3)

T = absolute temperature (K)

The general law of state for gases is a combination of Boyle's and Charles's laws. This states how pressure, volume and temperature will affect each other. When one of these variables is changed, this affects at least one of the other two variables.

This can be written:

$$\frac{p \times V}{T} = R$$

p = absolute pressure (Pa)

V = specific volume (m^3/kg)

T = absolute temperature (K)

$$R = \frac{\bar{R}}{M} = \text{individual gas constant } J / (kg \times K)$$

The individual gas constant R only depends on the properties of the gas. If a mass m of the gas takes up the volume V , the relation can be written:

$$p \times V = n \times \bar{R} \times T$$

p = absolute pressure (Pa)

V = volume (m^3)

n = number of moles

\bar{R} = universal gas constant

= 8.314 (J/mol \times K)

T = absolute temperature (K)

1.3.3 Heat transfer

Any temperature difference within a body or between different bodies or systems leads to the transfer of heat, until a temperature equilibrium is reached. This heat transfer can take place in three different ways: through conduction, convection or radiation. In real situations, heat transfer takes place simultaneously but not equally in all three ways.

Conduction is the transfer of heat by direct contact of particles. It takes place between solid bodies or between thin layers of a liquid or gas. Vibrating atoms give off a part of their kinetic energy to the adjacent atoms that vibrate less.

$$Q = -\lambda \times A \times t \times \frac{\Delta T}{\Delta x}$$

Q = heat transferred (J)

λ = thermal conductivity coefficient
(W/m \times K)

A = heat flow area (m^2)

t = time (s)

ΔT = temperature difference (cold – hot) (K)

Δx = distance (m)

Convection is the transfer of heat between a hot solid surface and the adjacent stationary or moving fluid (gas or liquid), enhanced by the mixing of one portion of the fluid with the other. It can occur as free convection, by natural movement in a medium as a result of differences in density due to temperature differences. It can also occur as forced convection with fluid movement caused by mechanical agents, for example a fan or a pump. Forced convection produces significantly higher heat transfer as a result of higher mixing velocities.

$$Q = -h \times A \times t \times \Delta T$$

Q = heat transferred (J)

h = heat transfer coefficient ($\text{W}/\text{m}^2 \times \text{K}$)

A = contact area (m^2)

t = time (s)

ΔT = temperature difference (cold – hot) (K)

Radiation is the transfer of heat through empty space. All bodies with a temperature above 0 K emit heat by electro-magnetic radiation in all directions. When heat rays hit a body, some of

the energy is absorbed and transformed to heat up that body. The rays that are not absorbed pass through the body or are reflected by it.

In real situations, heat transmission is the sum of the simultaneous heat transfer through conduction, convection and radiation.

Generally, the heat transmission relation below applies:

$$Q = -k \times A \times t \times \Delta T$$

Q = total heat transmitted (J)

k = total heat transfer coefficient ($\text{W}/\text{m}^2 \times \text{K}$)

A = area (m^2)

t = time (s)

ΔT = temperature difference (cold – hot) (K)

Heat transfer frequently occurs between two bodies that are separated by a wall. The total heat transfer coefficient “ k ” depends on the heat transfer coefficient of both sides of the wall and on the coefficient of thermal conductivity for the wall itself.

1:6

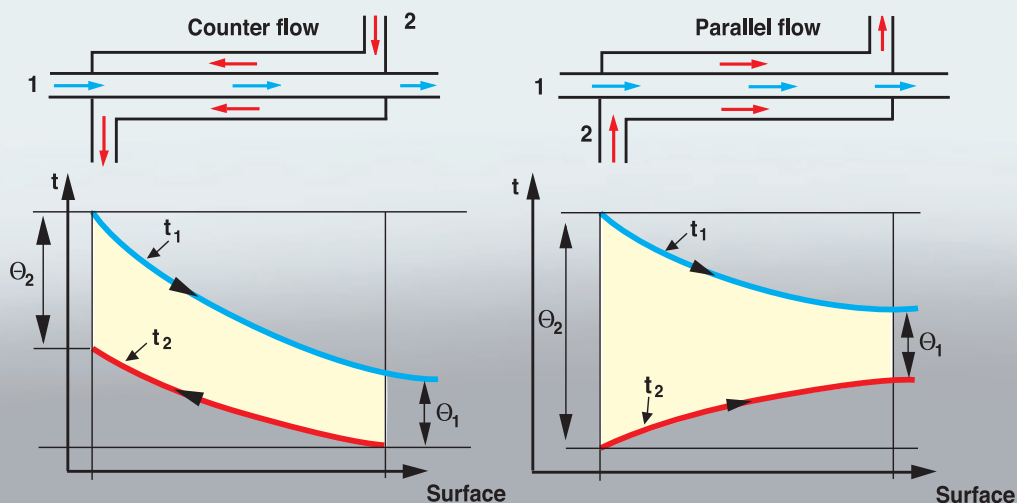

This illustrates the temperature gradient in counter flow and in parallel flow heat exchangers.

For a clean, flat wall the relation below applies:

$$\frac{1}{k} = \frac{1}{\alpha_1} + \frac{d}{\lambda} + \frac{1}{\alpha_2}$$

$\alpha_1, \alpha_2 =$ heat transfer coefficient on each side of the wall ($\text{W}/\text{m}^2 \times \text{K}$)

$d =$ thickness of the wall (m)

$\lambda =$ thermal conductivity for the wall ($\text{W}/\text{m} \times \text{K}$)

$k =$ total heat transfer coefficient ($\text{W}/\text{m}^2 \times \text{K}$)

The heat transmission in a heat exchanger is at each point a function of the prevailing temperature difference and of the total heat transfer coefficient. It requires the use of a logarithmic mean temperature difference Θ_m instead of a linear arithmetic ΔT .

The logarithmic mean temperature difference is defined as the relationship between the temperature differences at the heat exchanger's two connection sides according to the expression:

$$\Theta_m = \frac{\Theta_1 - \Theta_2}{\ln \frac{\Theta_1}{\Theta_2}}$$

$\Theta_m =$ logarithmic mean temperature difference (K)

1.3.4 Changes in state

Changes in state for a gas can be followed from one point to another in a p/V diagram. For real-life cases, three axes for the variables p, V and T are required. With a change in state, we are moved along a 3-dimensional curve on the surface in the p, V and T space.

However, to simplify, we usually consider the projection of the curve in one of the three planes. This is usually the p/V plane.

Five different changes in state can be considered:

- Isochoric process (constant volume),
- Isobaric process (constant pressure),
- Isothermal process (constant temperature),
- Isentropic process (without heat exchange with surroundings),
- Polytropic process (complete heat exchange with the surroundings).

1.3.4.1 Isochoric process

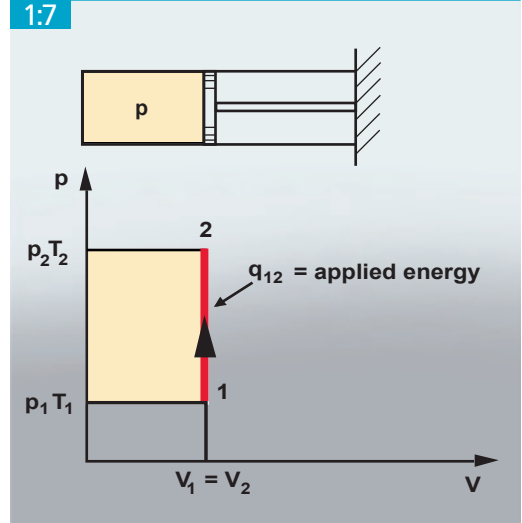

Isochoric change of state means that the pressure changes, while the volume is constant.

Heating a gas in an enclosed container is an example of the isochoric process at constant volume.

$$Q = m \times c_v \times (T_2 - T_1)$$

$Q =$ quantity of heat (J)

$m =$ mass (kg)

$c_v =$ specific heat at constant volume ($\text{J}/\text{kg} \times \text{K}$)

$T =$ absolute temperature (K)

1.3.4.2 Isobaric process

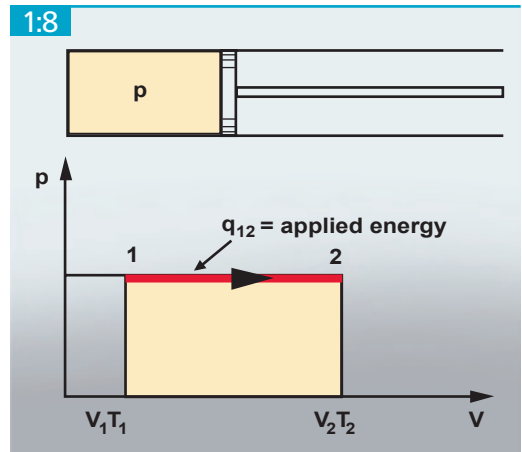

Isobaric change of state means that the volume changes, while the pressure is constant.

Heating a gas in a cylinder with a constant load on the piston is an example of the isobaric process at constant pressure.

$$Q = m \times c_p \times (T_2 - T_1)$$

Q = quantity of heat (J)

m = mass (kg)

c_p = specific heat at constant pressure (J/kg x K)

T = absolute temperature (K)

1.3.4.3 Isothermal process

1:9

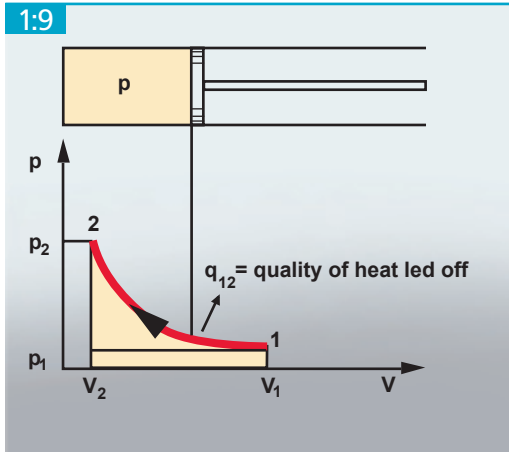

Isothermal change of state means that the pressure and volume are changed while the temperature remains constant.

If a gas in a cylinder is compressed isothermally, a quantity of heat equal to the applied work must be gradually removed. This is unpractical, as such a slow process cannot occur.

$$Q = m \times R \times T \times \ln\left(\frac{p_2}{p_1}\right)$$

$$Q = p_1 \times V_1 \times \ln\left(\frac{V_2}{V_1}\right)$$

Q = quantity of heat (J)

m = mass (kg)

R = individual gas constant (J/kg x K)

T = absolute temperature (K)

V = volume (m³)

p = absolute pressure (Pa)

1.3.4.4 Isentropic process

1:10

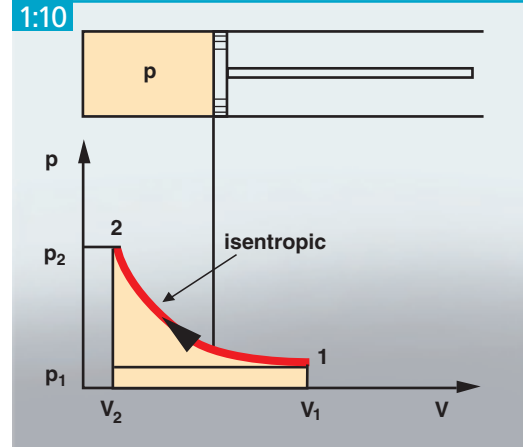

When the entropy in a gas being compressed or expanded is constant, no heat exchange with the surroundings takes place. This change in state follows Poisson's law.

An isentropic process exists if a gas is compressed in a fully-insulated cylinder without any heat exchange with the surroundings. It may also exist if a gas is expanded through a nozzle so quickly that no heat exchange with the surroundings has time to occur.

$$\frac{p_2}{p_1} = \left(\frac{V_1}{V_2}\right)^\kappa \quad \text{or} \quad \frac{p_2}{p_1} = \left(\frac{T_2}{T_1}\right)^{\frac{\kappa}{\kappa-1}}$$

p = absolute pressure (Pa)

V = volume (m³)

T = absolute temperature (K)

$\kappa = C_p / C_v$ = isentropic exponent

1.3.4.5 Polytropic process

The isothermal process involves full heat exchange with the surroundings and the isotropic process involves no heat exchange whatsoever. In reality, all processes occur somewhere in between these extreme: the polytropic process. The relation for such a process is:

$$p \times V^n = \text{constant}$$

p = absolute pressure (Pa)

V = volume (m³)

n = 0 for isobaric process

n = 1 for isothermal process

n = κ for isentropic process

n = ∞ for isochoric process

1.3.5 Gas flow through a nozzle

The gas flow through a nozzle depends on the pressure ratio on the respective sides of the nozzle. If the pressure after the nozzle is lowered, the flow increases. It only does so, however, until its pressure has reached half of the pressure before the nozzle. A further reduction of the pressure after the opening does not bring about an increase in flow.

This is the critical pressure ratio and it is dependent on the isentropic exponent (κ) of the particular gas. The critical pressure ratio also occurs when the flow velocity is equal to the sonic velocity in the nozzle's narrowest section.

The flow becomes supercritical if the pressure after the nozzle is reduced further, below the critical value. The relation for the flow through the nozzle is:

$$\dot{Q} = \alpha \times \psi \times p_1 \times A \times \sqrt{\left(\frac{2}{R \times T_1}\right)}$$

Q = mass flow (kg/s)

α = nozzle coefficient

ψ = flow coefficient

A = minimum area (m²)

R = individual gas constant (J/kg × K)

T_1 = absolute temperature before nozzle (K)

p_1 = absolute pressure before nozzle (Pa)

1.3.6 Flow through pipes

The Reynolds number is a dimensionless ratio between inertia and friction in a flowing medium. It is defined as:

$$Re = D \times w \times \frac{\rho}{\eta}$$

D = characteristic dimension
(e.g. the pipe diameter) (m)

w = mean flow velocity (m/s)

ρ = density of the flowing medium (kg/m³)

η = medium dynamic viscosity (Pa·s)

In principal, there are two types of flow in a pipe. With $Re < 2000$ the viscous forces dominate in the medium and the flow becomes laminar. This means that different layers of the medium move

in relation to each other in the proper order. The velocity distribution across the laminar layers is usually parabolic shaped.

With $Re \geq 4000$ the inertia forces dominate the behavior of the flowing medium and the flow becomes turbulent, with particles moving randomly across the flow. The velocity distribution across a layer with turbulent flow becomes diffuse.

In the critical area, between $Re \leq 2000$ and $Re \geq 4000$, the flow conditions are undetermined, either laminar, turbulent or a mixture of the both. The conditions are governed by factors such as the surface smoothness of the pipe or the presence of other disturbances.

To start a flow in a pipe requires a specific pressure difference to overcome the friction in the pipe and the couplings. The amount of the pressure difference depends on the diameter of the pipe, its length and form as well as the surface smoothness and Reynolds number.

1.3.7 Throttling

When an ideal gas flows through a restrictor with a constant pressure before and after the restrictor, the temperature remains constant. However, a pressure drop occurs across the restrictor, through the inner energy being transformed into kinetic energy. This is the reason for which the temperature falls. For real gases, this temperature change becomes permanent, even though the energy content of the gas remains constant. This is called the Joule-Thomson effect. The temperature change is equal to the pressure change across the throttling multiplied by the Joule-Thomson coefficient.

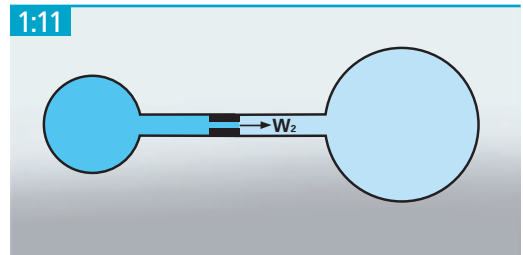

When an ideal gas flows through a small opening between two large containers, the energy becomes constant and no heat exchange takes place. However, a pressure drop occurs with the passage through the restrictor.

If the flowing medium has a sufficiently low temperature ($\leq +329^\circ\text{C}$ for air), a temperature drop occurs with the throttling across the restrictor, but if the flow medium is hotter, a temperature increase occurs instead. This condition is used in several technical applications, for example, in refrigeration technology and in separation of gases.

1.4 AIR

1.4.1 Air in general

Air is a colorless, odorless and tasteless gas mixture. It is a mixture of many gases, but is primarily composed of oxygen (21%) and nitrogen (78%). This composition is relatively constant, from sea level up to an altitude of 25 kilometers.

Air is not a pure chemical substance, but a mechanically-mixed substance. This is why it can be separated into its constituent elements, for example, by cooling.

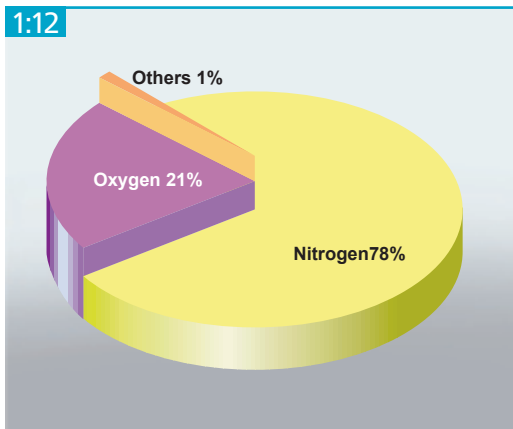

Air is a gas mixture that primarily consists of oxygen and nitrogen. Only approx. 1% is made up of other gases.

Atmospheric air is always more or less contaminated with solid particles, for example, dust, sand, soot and salt crystals. The degree of contamination is higher in populated areas, and lower in the countryside and at higher altitudes.

1.4.2 Moist air

Air can be considered a mixture of dry air and water vapor. Air that contains water vapor is called moist air, but the air's humidity can vary within broad limits. Extremes are completely dry air and air saturated with moisture. The maximum water vapor pressure that air can hold increases with rising temperatures. A maximum water vapor pressure corresponds to each temperature.

Air usually does not contain so much water vapor that maximum pressure is reached. Relative vapor pressure (also known as relative humidity) is a state between the actual partial vapor pressure and the saturated pressure at the same temperature.

The dew point is the temperature when air is saturated with water vapor. Thereafter, if the temperature falls, the water condenses. Atmospheric dew point is the temperature at which water vapor starts to condense at atmospheric pressure. Pressure dew point is the equivalent temperature with increased pressure. The following relation applies:

$$(p - \varphi \times p_s) \times V = R_a \times m_a \times T$$

$$\varphi \times p_s \times V = R_v \times m_v \times T$$

p = total absolute pressure (Pa)

p_s = saturation pressure at actual temp. (Pa)

φ = relative vapor pressure

V = total volume of the moist air (m^3)

R_a = gas constant for dry air = $287 \text{ J/kg} \times \text{K}$

R_v = gas constant for water vapor = $462 \text{ J/kg} \times \text{K}$

m_a = mass of the dry air (kg)

m_v = mass of the water vapor (kg)

T = absolute temperature of the moist air (K)

1.5 TYPES OF COMPRESSORS

1.5.1 Two basic principles

There are two generic principles for the compression of air (or gas): positive displacement compression and dynamic compression.

Positive displacement compressors include, for example, reciprocating (piston) compressors, orbital (scroll) compressors and different types of rotary compressors (screw, tooth, vane).

In positive displacement compression, the air is drawn into one or more compression chambers, which are then closed from the inlet. Gradually the volume of each chamber decreases and the air is compressed internally. When the pressure has reached the designed build-in pressure ratio, a port or valve is opened and the air is discharged into the outlet system due to continued reduction of the compression chamber's volume.

In dynamic compression, air is drawn between the blades on a rapidly rotating compression impeller and accelerates to a high velocity. The gas is then discharged through a diffuser, where the kinetic energy is transformed into static pressure. Most dynamic compressors are turbo-compressors with an axial or radial flow pattern. All are designed for large volume flow rates.

1.5.2 Positive displacement compressors

A bicycle pump is the simplest form of a positive displacement compressor, where air is drawn into a cylinder and is compressed by a moving piston. The piston compressor has the same operating principle and uses a piston whose forward and backward movement is accomplished by a connecting rod and a rotating crankshaft. If only one side of the piston is used for compression this is called a single-acting compressor. If both the piston's top and undersides are used, the compressor is double acting.

The pressure ratio is the relationship between absolute pressure on the inlet and outlet sides. Accordingly, a machine that draws in air at atmospheric pressure (1 bar(a)) and compresses it to

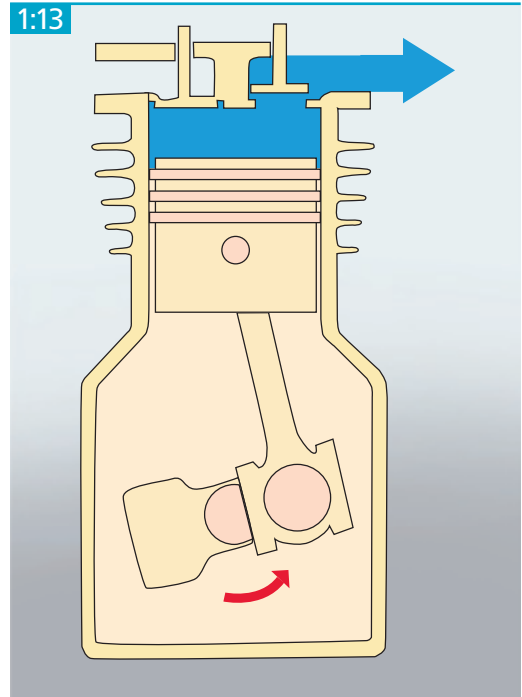

Single stage, single acting piston compressor.

7 bar overpressure works at a pressure ratio of $(7 + 1)/1 = 8$.

1.5.3 The compressor diagram for displacement compressors

Figure 1:15 illustrates the pressure-volume relationship for a theoretical compressor and figure 1:16 illustrates a more realistic compressor diagram for a piston compressor. The stroke volume is the cylinder volume that the piston travels during the suction stage. The clearance volume is the volume just underneath the inlet and outlet valves and above the piston, which must remain at the piston's top turning point for mechanical reasons.

The difference between the stroke volume and the suction volume is due to the expansion of the air remaining in the clearance volume before suction can start. The difference between the theoretical p/V diagram and the actual diagram is due to the practical design of a compressor, e.g. a piston compressor. The valves are never completely sealed and there is always a degree of leakage between the piston skirt and the cylinder wall. In addition, the valves can not fully open and close

1:14

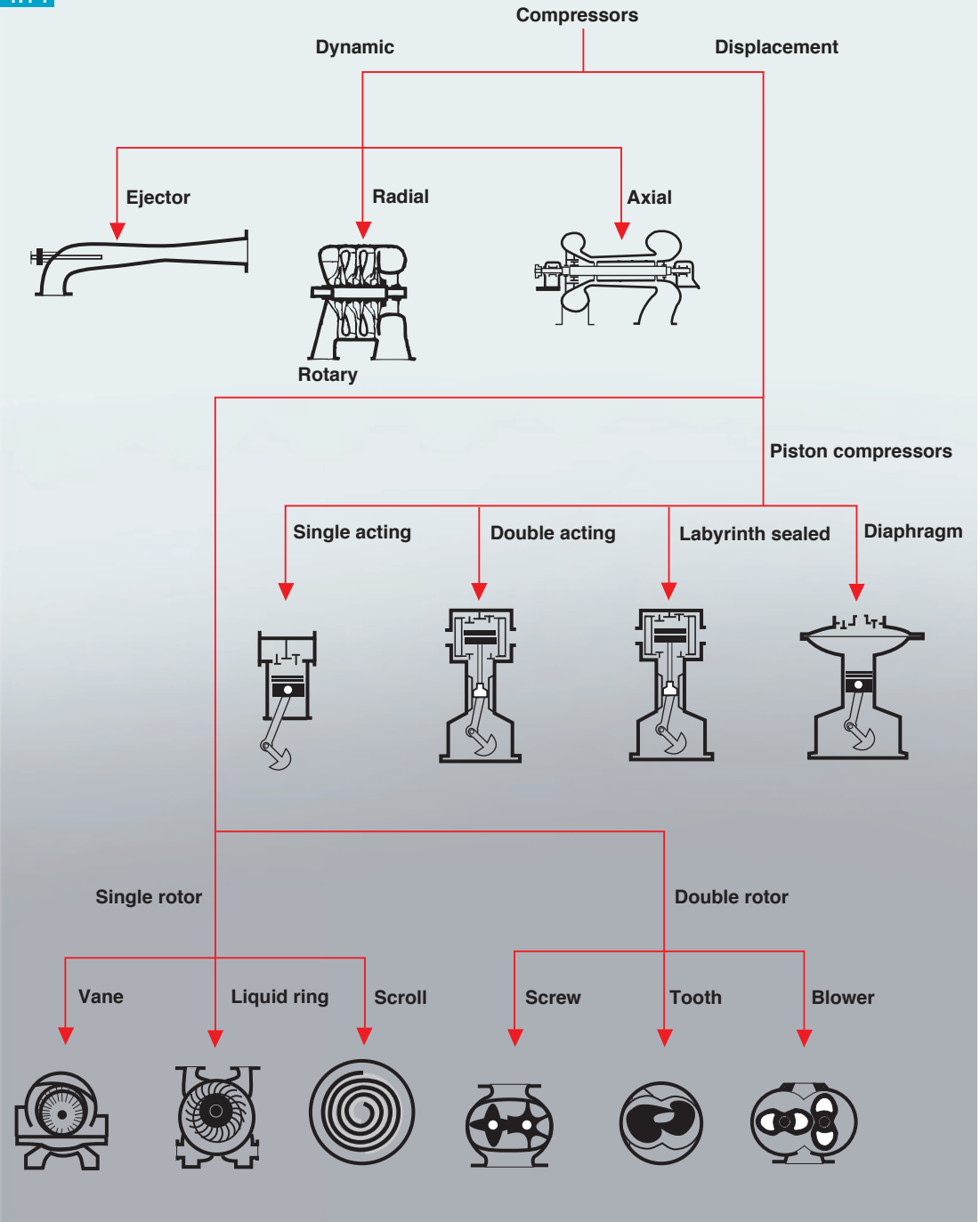

Most common compressor types, divided according to their working principles.

1:15

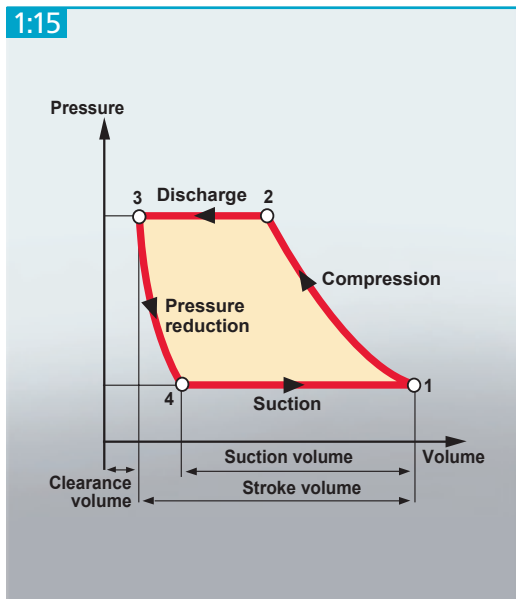

This illustrates how a piston compressor works in theory with self-acting valves. The p/V diagram shows the process without losses, with complete filling and emptying of the cylinder.

1:16

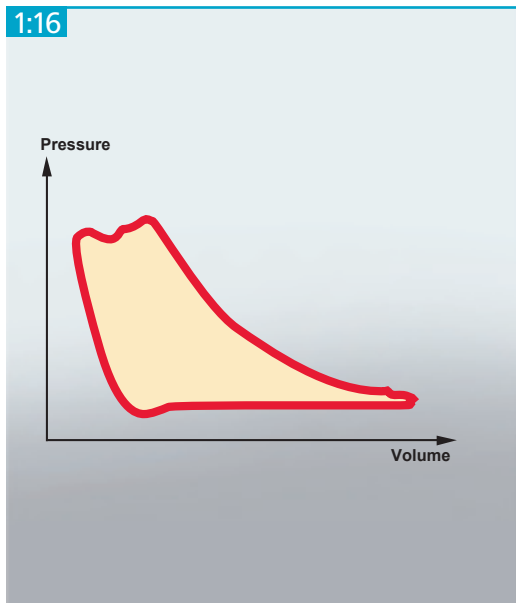

This illustrates a realistic p/V diagram for a piston compressor. The pressure drop on the inlet side and the over-pressure on the discharge side are minimized by providing sufficient valve area.

without a minimal delay, which results in a pressure drop when the gas flows through the channels. The gas is also heated when flowing into the cylinder as a consequence of this design.

Compression work with isothermal compression:

$$W = p_1 \times V_1 \times \ln\left(\frac{p_2}{p_1}\right)$$

Compression work with isentropic compression:

$$W = \frac{K}{K-1} \times (p_2 V_2 - p_1 V_1)$$

- W = compression work (J)
- p_1 = initial pressure (Pa)
- V_1 = initial volume (m³)
- p_2 = final pressure (Pa)
- K = isentropic exponent: $K \approx 1,3 - 1,4$

These relations show that more work is required for isentropic compression than for isothermal compression.

1.5.4 Dynamic compressors

In a dynamic compressor, the pressure increase takes place while the gas flows. The flowing gas accelerates to a high velocity by means of the rotating blades on an impeller. The velocity of the gas is subsequently transformed into static pressure when it is forced to decelerate under expansion in a diffuser. Depending on the main direction of the gas flow used, these compressors are called radial or axial compressors.

1:17

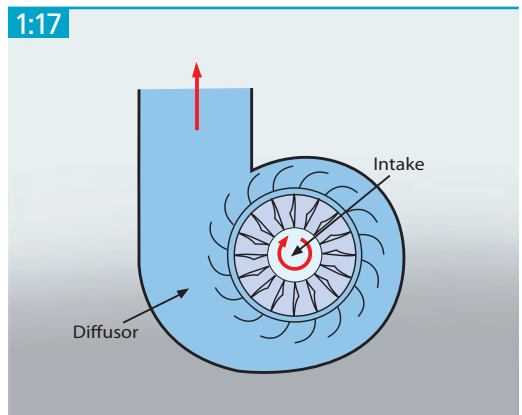

Radial turbocompressor.

As compared to displacement compressors, dynamic compressors have a characteristic whereby a small change in the working pressure results in a large change in the flow rate. See figure 1:19.

Each impeller speed has an upper and lower flow rate limit. The upper limit means that the gas flow velocity reaches sonic velocity. The lower limit means that the counterpressure becomes greater than the compressor's pressure build-up, which means return flow inside the compressor. This in turn results in pulsation, noise and the risk for mechanical damage.

1.5.5 Compression in several stages

In theory, air or gas may be compressed isentropically (at constant entropy) or isothermally (at constant temperature). Either process may be part of a theoretically reversible cycle. If the compressed gas could be used immediately at its final temperature after compression, the isentropic compression process would have certain advantages. In reality, the air or gas is rarely used directly after compression, and is usually cooled to ambient temperature before use. Consequently, the isothermal compression process is preferred, as it requires less work.

A common, practical approach to executing this isothermal compression process involves cooling the gas during compression. At an effective

working pressure of 7 bar, isentropic compression theoretically requires 37% higher energy than isothermal compression.

A practical method to reduce the heating of the gas is to divide the compression into several stages. The gas is cooled after each stage before being compressed further to the final pressure. This also increases the energy efficiency, with the best result being obtained when each compression stage has the same pressure ratio. By increasing the number of compression stages, the entire process approaches isothermal compression. However, there is an economic limit for the number of stages the design of a real installation can use.

1.5.6 Comparison: turbocompressor and positive displacement

At constant rotational speed, the pressure/flow curve for a turbocompressor differs significantly from an equivalent curve for a positive displacement compressor. The turbocompressor is a machine with a variable flow rate and variable pressure characteristic. On the other hand, a displacement compressor is a machine with a constant flow rate and a variable pressure.

A displacement compressor provides a higher pressure ratio even at a low speed. Turbocompressors are designed for large air flow rates.

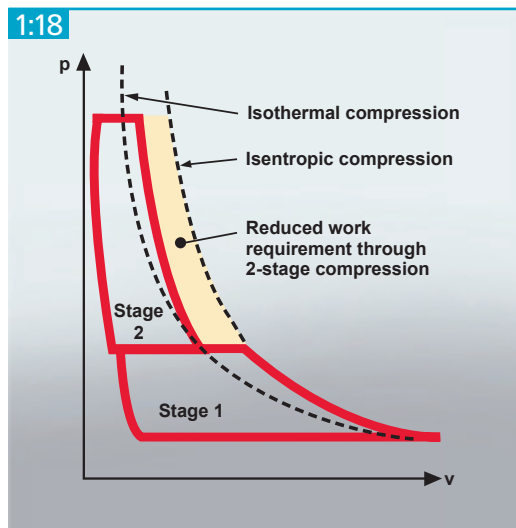

The colored area represents the work saved by dividing compression into two stages.

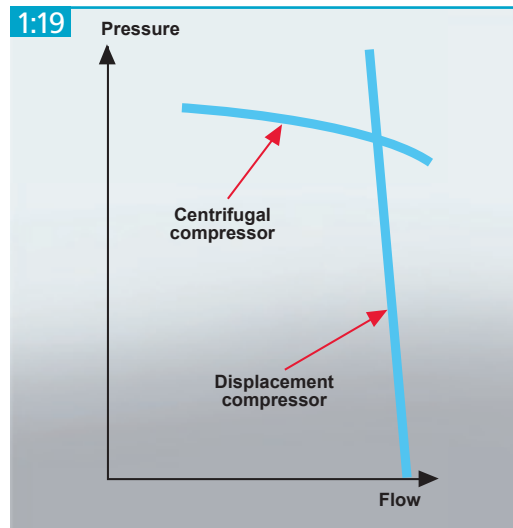

This illustrates the load curves for centrifugal respective displacement compressors when the load is changed at a constant speed.

1.6 ELECTRICITY

1.6.1 Basic terminology and definitions

Electricity is the result of electrons being separated temporarily from protons, thereby creating a difference in electric potential (or voltage) between the area with excess electrons and the area with a shortage of electrons. When electrons find an electrically-conductive path to move along, electric current flows.

The first electric applications made use of Direct Current (DC) power, whereby the electrical charge from the electron flow is uni-directional. DC is produced by batteries, photovoltaic (PV) solar cells and generators.

The alternating current used, for example, to power offices and workshops and to make standard, fixed-speed motors rotate, is generated by an alternator. It periodically changes magnitude and direction in a smooth, sinusoidal pattern. Voltage as well as current magnitude grows from zero to a maximum value, then falls to zero, changes direction, grows to a maximum value in the opposite direction and then becomes zero again. The current has then completed a period T , measured in seconds, in which it has gone through all of its values. The frequency is the inverse of the period, states the number of completed cycles per second, and is measured in Hertz.

$$f = \frac{1}{T}$$

f = frequency (Hz)

T = time for one period (s)

Magnitudes of current or voltage are usually indicated by the root mean square (RMS) value over one period. With a sinusoidal pattern, the relation for the current and voltage root mean square value is:

$$\text{root mean square} = \frac{\text{peak value}}{\sqrt{2}}$$

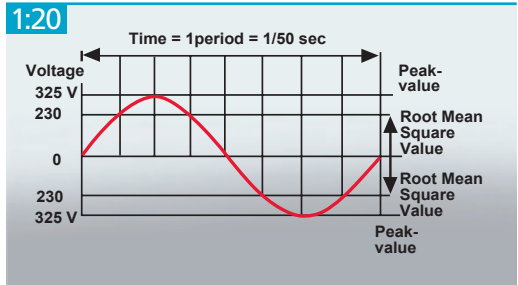

This shows one period of a sinusoidal voltage (50 Hz).

Periodic but non-sinusoidal current and voltage waveforms are anything that is not a pure sinusoidal waveform. Simplified examples are square, triangular or rectangular waveforms. Often they are derived from mathematical functions, and can be represented by a combination of pure sine waves of different frequencies, sometimes multiples of the lowest (called the fundamental) frequency.

$$\text{current: } i(t) = I_0 + i_1(t) + i_2(t) + \dots + i_n(t) + \dots$$

$$\text{voltage: } v(t) = V_0 + v_1(t) + v_2(t) + \dots + v_n(t) + \dots$$

1.6.2 Ohm's law for alternating current

An alternating current that passes through a coil gives rise to a magnetic flow. This flow changes magnitude and direction in the same way that an electric current does. When the flow changes, an emf (electromotive force) is generated in the coil, according to the laws of induction. This emf is counter-directed to the connected pole voltage. This phenomenon is called self-induction.

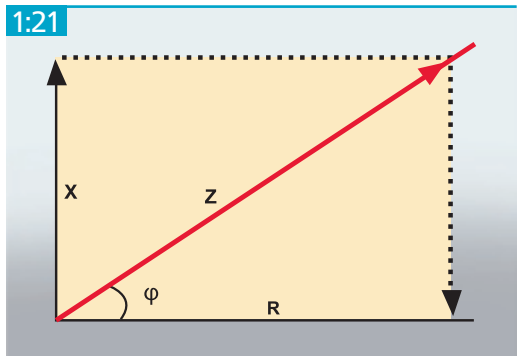

Relation between Reactance (X) – Resistance (R) – Impedance (Z) – Phase displacement (ϕ).

1:22

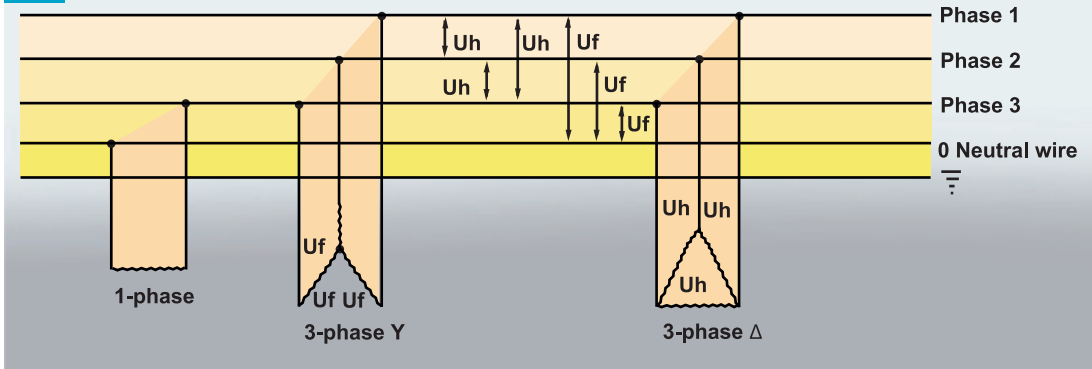

This illustrates the different connection options for a three-phase system. The voltage between the two phase conductors is called the main voltage (U_h). The voltage between one phase conductor and the neutral wire are called phase voltage (U_f). The Phase voltage = Main voltage/ $\sqrt{3}$.

Self-induction in an alternating current unit gives rise in part to phase displacement between the current and the voltage, and in part to an inductive voltage drop. The unit's resistance to the alternating current becomes apparently greater than that calculated or measured with direct current.

Phase displacement between the current and voltage is represented by the angle ϕ . Inductive resistance (called reactance) is represented by X . Resistance is represented by R . Apparent resistance in a unit or conductor is represented by Z .

$$Z = \sqrt{R^2 + X^2}$$

Z = impedance (Ω) (Ohm)

R = resistance (Ω)

X = reactance (Ω)

Ohm's law for alternating current:

$$U = I \times Z$$

U = voltage (V)

I = current (A)

Z = impedance (Ω)

1.6.3 Three-phase system

The power of a single alternating current phase fluctuates. For domestic use, this does not truly present a problem. However, for the operation of electric motors it is advisable to use a current that produces more constant power. This is obtained

by using three separate power lines with alternating current, running in parallel but with each current phase shifted by 1/3 of a cycle in relation to the other phases.

Three-phase alternating current is produced at the power station in a generator with three separate windings. A single phase application can be connected between the phase and zero. Three-phase applications can be connected using all three phases in two ways, in a star (Y) or delta (Δ) configuration. With the star connection, a phase voltage lies between the outlets. With a delta connection, a main voltage lies between the outlets.

Industrial compressors were among the first industrial machines to be equipped with Variable Speed Drives (VSD), also called Variable Frequency Drives, to control the rotational speed and torque of AC induction motors by controlling the frequency of the electric power lines to the motor. The most common design converts the three phases of the AC input power to DC power using a rectifier bridge. This DC power is converted into quasi-sinusoidal AC power by using an inverter switching circuit (now IGBT-type power semiconductor switches) and pulse width modulation (PWM) techniques.

1.6.4 Power

Active power P (in Watts) is the useful power that can be used for work. A Watt-meter only measures the current component that is in phase with the voltage. This is the current flowing through the resistance in the circuit.

Reactive power Q (VAR) is the “useless” power or “out-of-phase” or “phantom” power and cannot be used for work. However, it is useful for providing the magnetizing field necessary for the motor.

Apparent power S (VA) is the power that must be consumed from the mains supply to gain access to active power. It includes the active and reactive power and any heat losses from the electric distribution system.

$$P = U \times I \times \cos \phi$$

$$Q = U \times I \times \sin \phi$$

$$S = U \times I$$

$$\cos \phi = \frac{P}{S}$$

U = voltage (V)

I = current (A)

ϕ = phase angle

The active power for three-phase star and delta configurations is:

$$P = \sqrt{3} \times U \times I \times \cos \phi$$

$$Q = \sqrt{3} \times U \times I \times \sin \phi$$

$$S = U \times I$$

$$\cos \phi = \frac{P}{S}$$

The relationship between active, reactive and apparent power is usually illustrated by a power triangle. The phase angle expresses the degree to which current and voltage are out of phase. A quantity known as the Power Factor (PF) is equal to $\cos \phi$.

Many power utilities apply a penalty to their consumers for applications with a low, lagging Power Factor. This is because the electric distribution, transmission and generating equipment must be substantially oversized to accommodate the apparent power (sum of active and reactive power and of heat losses), while consumers are billed based on kWh (kilowatt hour) consumption registering active power only.

Power Factor improvements often result in substantial cost savings. The PF can be improved by reducing the reactive power by:

- Using high PF equipment: lighting ballasts
- Using synchronous motors operated at leading PF and at constant load
- Using PF improvement capacitors

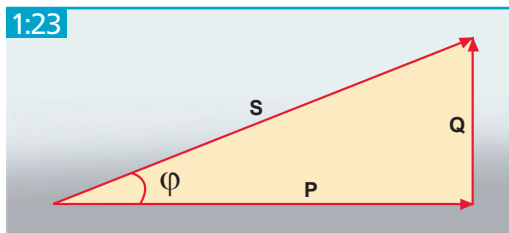

This illustrates the relation between apparent power (S), reactive power (Q) and active power (P). The angle ϕ between S and P gives the power factor $\cos(\phi)$.

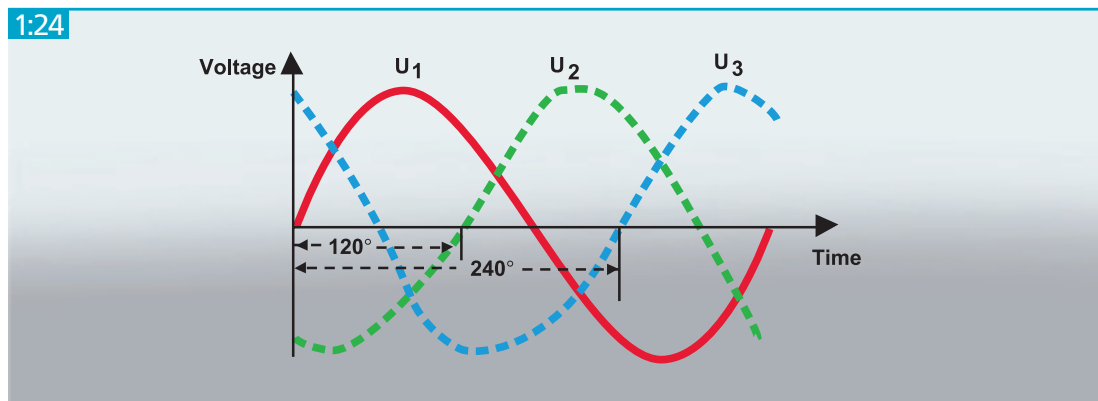

The displacement between the generator’s windings gives a sinusoidal voltage curve on the system. The maximum value is displaced at the same interval as the generator’s windings.

1.6.5 The electric motor

The most common electric motor is a three-phase squirrel cage induction motor. This type of motor is used in all types of industries. It is silent and reliable, and is therefore a part of most systems, including compressors. The electric motor consists of two main parts, the stationary stator and the rotating rotor. The stator produces a rotating magnetic field and the rotor converts this energy into movement, i.e. mechanical energy.

The stator is connected to the three-phase mains supply. The current in the stator windings give rise to a rotating magnetic force field, which induces currents in the rotor and gives rise to a magnetic field there as well. The interaction between the stator's and the rotor's magnetic fields creates turning torque, which in turn makes the rotor shaft rotate.

1.6.5.1 Rotation speed

If the induction motor shaft rotated at the same speed as the magnetic field, the induced current in the rotor would be zero. However, due to various losses in, for example, the bearings, this is impossible and the speed is always approx. 1-5% below magnetic field synchronous speed (called "slip").

(Permanent magnet motors do not produce any slip at all.)

$$n = \frac{120 \times f}{p}$$

n = synchronous speed (rev/min)

f = motor supply frequency (Hz)

p = number of poles per phase (even number)

1.6.5.2 Efficiency

Energy conversion in a motor does not take place without losses. These losses are the result, among other things, of resistive losses, ventilation losses, magnetization losses and friction losses.

$$\eta = \frac{P_2}{P_1}$$

η = efficiency

P_2 = stated power, shaft power (W)

P_1 = applied electric power (W)

P_2 is always the power stated on the motor data plate.

1.6.5.3 Insulation class

The insulation material in the motor's windings is divided into insulation classes in accordance with IEC 60085, a standard published by the International Electro-Technical Commission. A letter corresponding to the temperature, which is the upper limit for the isolation application area, designates each class.

If the upper limit is exceeded by 10°C over a sustained period of time, the service life of the insulation is shortened by about half.

Insulation class	B	F	H
Max. winding temp. °C	130	155	180
Ambient temperature °C	40	40	40
Temperature increase °C	80	105	125
Thermal margin °C	10	10	15

1.6.5.4 Protection classes

Protection classes, according to IEC 60034-5, specify how the motor is protected against contact and water. These are stated with the letters IP and two digits. The first digit states the protection against contact and penetration by a solid object. The second digit states the protection against water. For example, IP23 represents: (2) protection against solid objects greater than 12 mm, (3) protection against direct sprays of water up to 60° from the vertical. IP 54: (5) protection against dust, (4) protection against water sprayed from all directions. IP 55: (5) protection against dust, (5) protection against low-pressure jets of water from all directions.

1.6.5.5 Cooling methods

Cooling methods according to IEC 60034-6 specify how the motor is cooled. This is designated with the letters IC followed by a series of digits representing the cooling type (non-ventilated, self-ventilated, forced cooling) and the cooling mode of operation (internal cooling, surface cooling, closed-circuit cooling, liquid cooling etc.).

1.6.5.6 Installation method

The installation method states, according to IEC 60034-7, how the motor should be installed. This is designated by the letters IM and four digits. For example, IM 1001 represents: two bearings, a shaft with a free journal end, and a stator body with feet. IM 3001: two bearings, a shaft with a free journal end, a stator body without feet, and a large flange with plain securing holes.

1.6.5.7 Star (Y) and delta (Δ) connections

A three-phase electric motor can be connected in two ways: star (Y) or delta (Δ). The winding phases in a three-phase motor are marked U, V and W (U1-U2; V1-V2; W1-W2). Standards in the United States make reference to T1, T2, T3, T4, T5, T6. With the star (Y) connection the “ends” of motor winding’s phases are joined together to form a zero point, which looks like a star (Y).

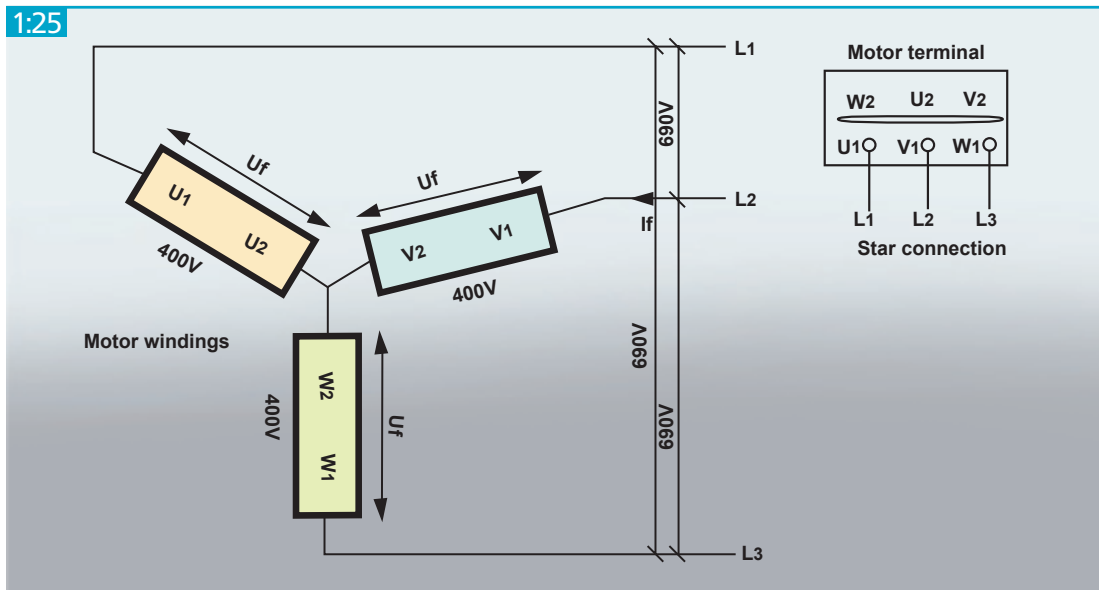

This illustrates the motor windings connected in a star configuration, and how the connection strips are placed on the star-connected motor terminal. The example shows the connection to a 690V supply.

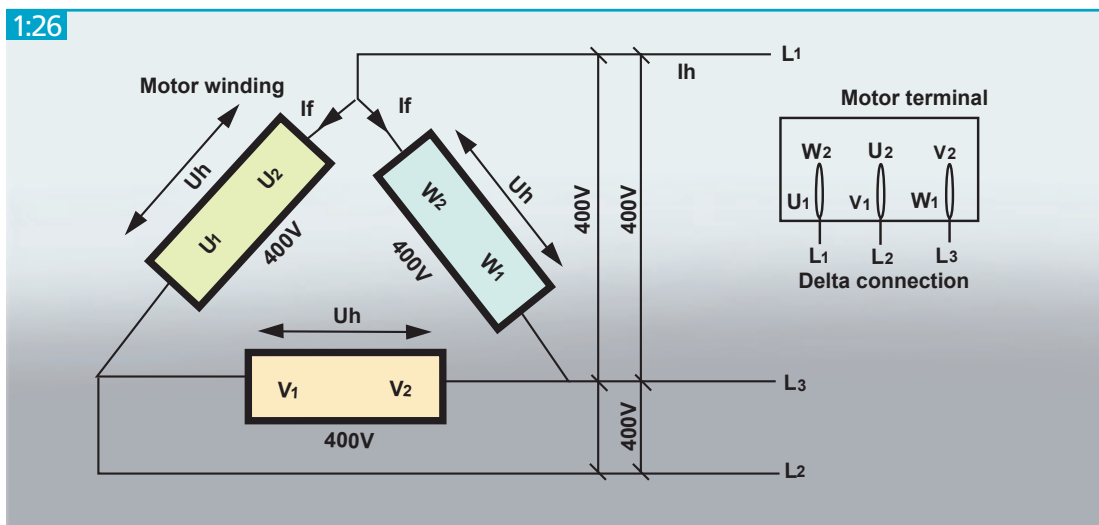

This illustrates the motor windings connected in a delta configuration, and how the connection strips are placed on the delta-connected motor terminal. The example shows the connection to a 400V supply.

1:27

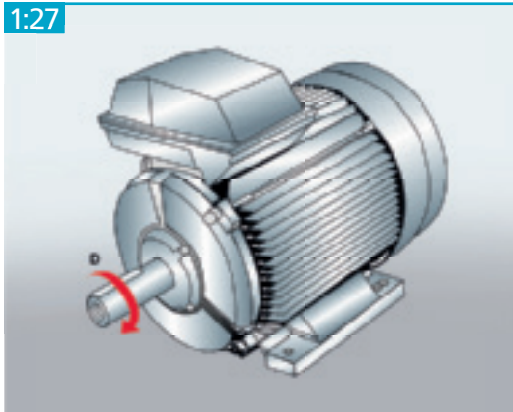

The mains supply is connected to a three-phase motor's terminals marked U, V and W. The phase sequence is L1, L2 and L3. This means the motor will rotate clockwise seen from "D" the drive end. To make the motor rotate anticlockwise two of the three conductors connected to the starter or to the motor are switched. Check the operation of the cooling fan when rotating anticlockwise.

A phase voltage (phase voltage = main voltage/ $\sqrt{3}$; for example $400\text{V} = 690/\sqrt{3}$) will lie across the windings. The current I_h in towards the zero point becomes a phase current and accordingly a phase current will flow $I_f = I_h$ through the windings.

With the delta (Δ) connection the beginning and ends are joined between the different phases, which then form a delta (Δ). As a result, there will be a main voltage across the windings. The current I_h into the motor is the main current and this will be divided between the windings to give a phase current through these, $I_h/\sqrt{3} = I_f$. The same motor can be connected as a 690 V star connection or 400 V delta connection. In both cases the voltage across the windings will be 400 V. The current to the motor will be lower with a 690 V star connection than with a 400 V delta connection. The relation between the current levels is $\sqrt{3}$.

On the motor plate it can, for example, state 690/400 V. This means that the star connection is intended for the higher voltage and the delta connection for the lower. The current, which can also be stated on the plate, shows the lower value for the star-connected motor and the higher for the delta-connected motor.

1.6.5.8 Torque

An electric motor's turning torque is an expression of the rotor turning capacity. Each motor has a maximum torque. A load above this torque means that the motor does not have the capability to rotate. With a normal load the motor works significantly below its maximum torque, however, the start sequence will involve an extra load. The characteristics of the motor are usually presented in a torque curve.

1:28

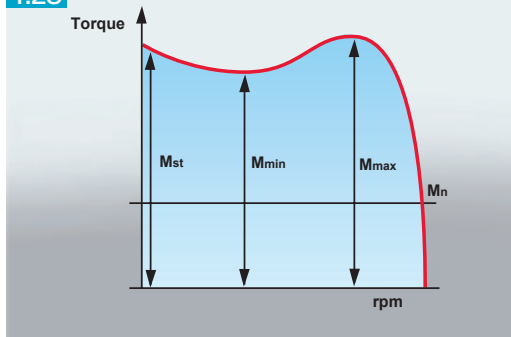

The torque curve for a squirrel cage induction motor. When the motor starts the torque is high.

M_{st} = start torque, M_{max} = max torque ("cutting torque"),
 M_{min} = min. torque ("saddle torque"),
 M_n = rated torque.

1:29

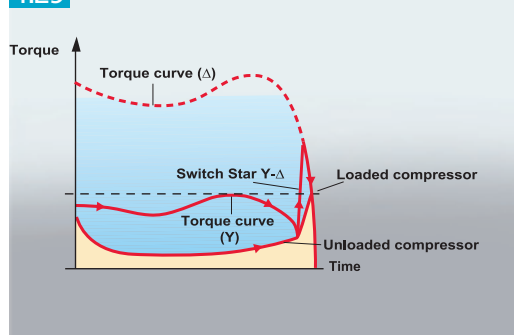

A star/delta started induction motor torque curve combined with a torque demand curve for a screw compressor. The compressor is unloaded (idling) during star operations. When the speed has reached approx. 90-95% of the rated speed the motor is switched to the delta mode, the torque increases, the compressor is loaded and finds its working point.

1 COMPRESSORS AND AUXILIARY EQUIPMENT

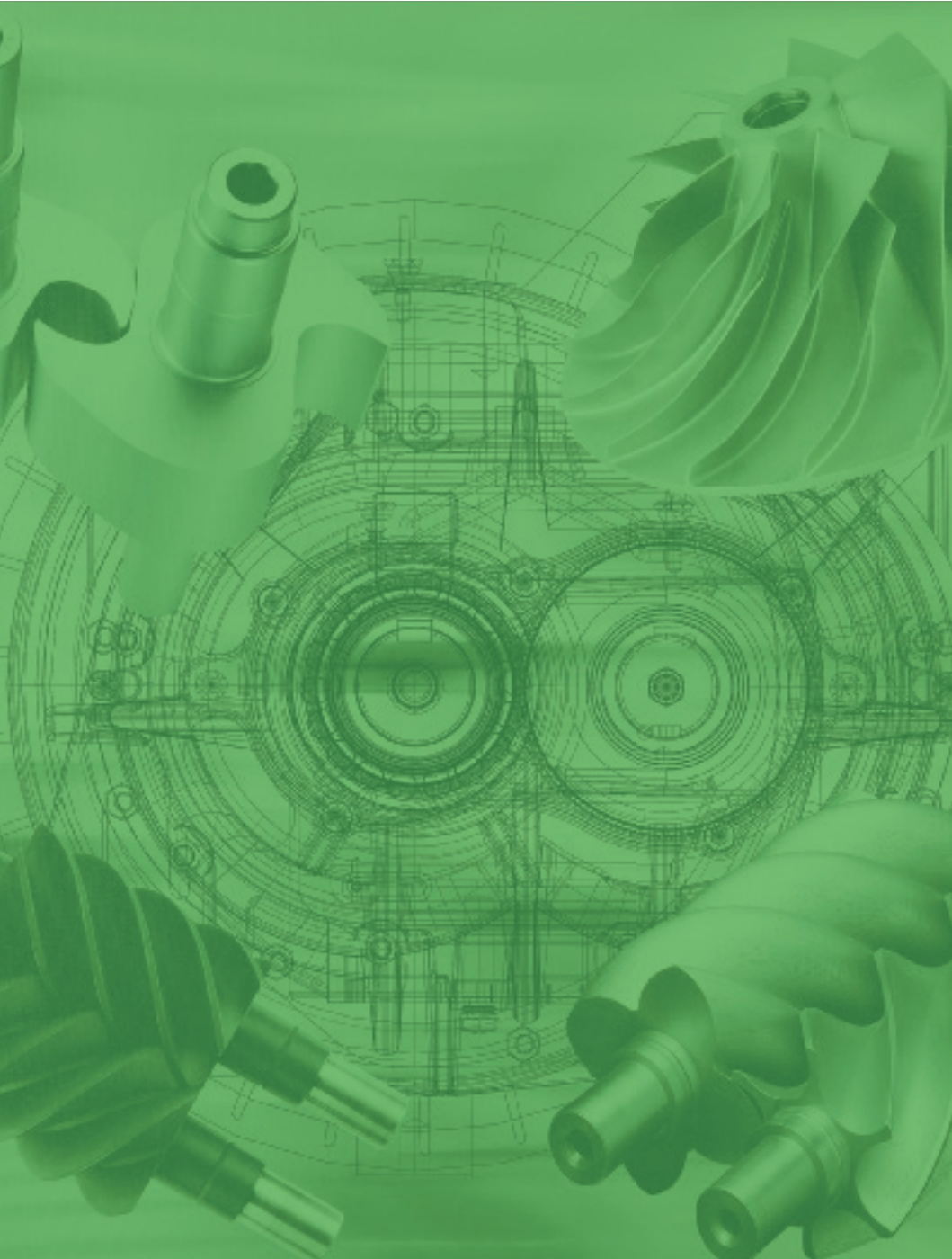

2.1 DISPLACEMENT COMPRESSORS

2.1.1 Displacement compressors

A displacement compressor encloses a volume of gas or air and then increases the pressure by reducing the enclosed volume through the displacement of one or more moving members.

2.1.2 Piston compressors

The piston compressor is the oldest and most common of all industrial compressors. It is available in single-acting or double-acting, oil-lubricated or oil-free variants, with various numbers of cylinders in different configurations. With the exception of very small compressors having vertical cylinders, the V-configuration is the most common for small compressors.

On double-acting, large compressors the L-configuration with a vertical low pressure cylinder and horizontal high pressure cylinder offers immense benefits and has become the most common design.

Oil-lubricated compressors normally work with splash lubrication or pressure lubrication. Most compressors have self-acting valves. A self-acting valve opens and closes through the effect of pressure differences on both sides of the valve disk.

2.1.3 Oil-free piston compressors

Oil-free piston compressors have piston rings made of PTFE or carbon, and alternatively, the piston and cylinder wall can be profiled (toothed) as on labyrinth compressors. Larger machines are equipped with a crosshead and seals on the gudgeon pins, and a ventilated intermediate piece to prevent oil from being transferred from the crankcase and into the compression chamber. Smaller compressors often have a crankcase with bearings that are permanently sealed.

2:1

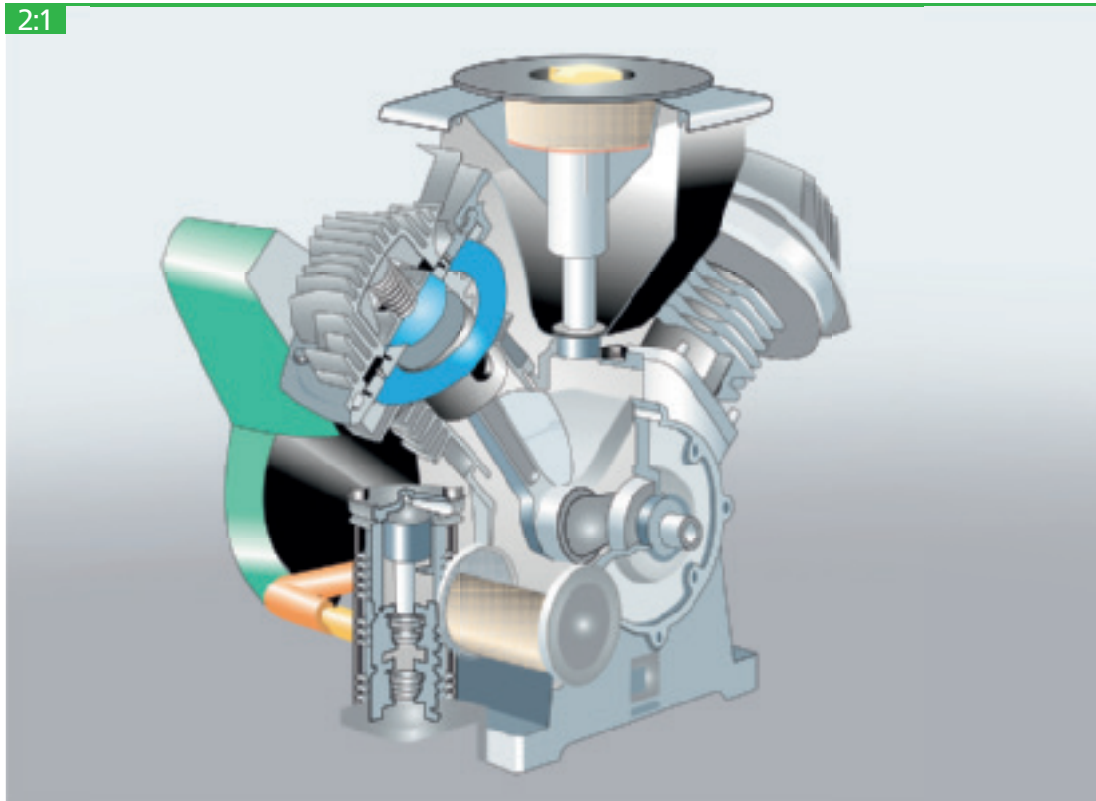

Piston compressor.

2:2

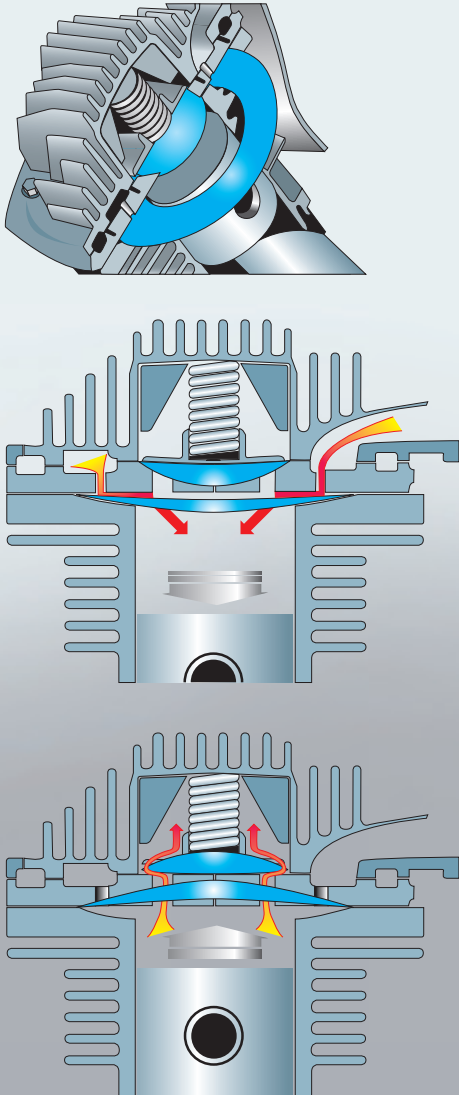

Piston compressor with a valve system consisting of two stainless steel valve discs.

When the piston moves downwards and draws in air into the cylinder the largest disc flexes to fold downwards allowing air to pass.

When the piston moves upwards, the large disc folds upwards and seals against the seat. The small disc's flexi-function then allows the compressed air to be forced through the hole in the valve seat.

2:3

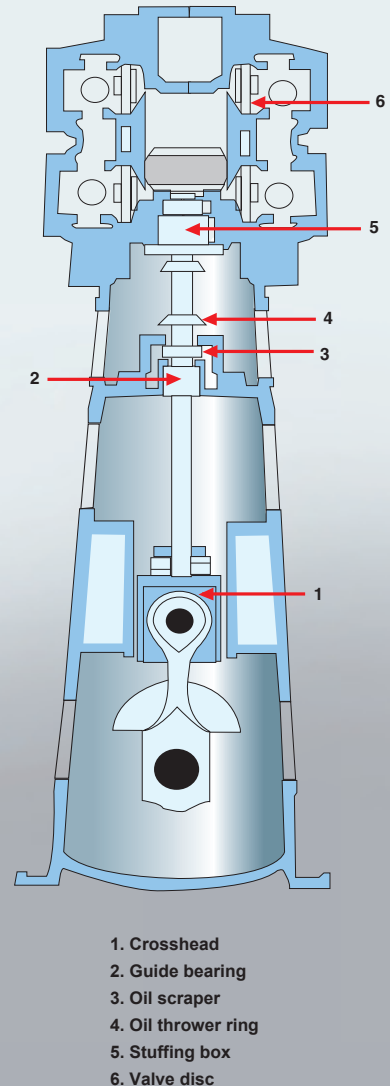

1. Crosshead
2. Guide bearing
3. Oil scraper
4. Oil thrower ring
5. Stuffing box
6. Valve disc

Labyrinth sealed, double acting oil-free piston compressor with crosshead.

2:4

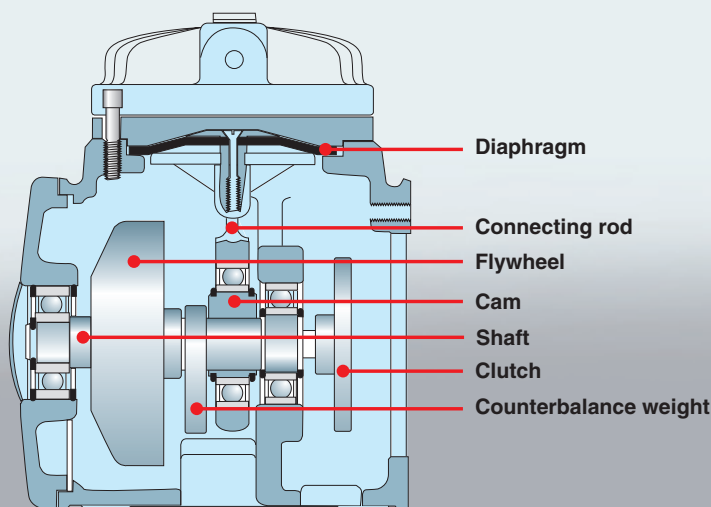

Mechanical diaphragm compressor, in which a conventional crankshaft transfers the reciprocating motion via a connecting rod to the diaphragm.

2.1.4 Diaphragm compressor

Diaphragm compressors form another group. Their diaphragm is actuated mechanically or hydraulically. The mechanical diaphragm compressors are used with a small flow and low pressure or as vacuum pumps. Hydraulic diaphragm compressors are used for high pressure applications.

2.1.5 Twin screw compressors

The principle for a rotating displacement compressor in twin screw form was developed during the 1930s, when a rotating compressor with high flow rate and stable flow under varying pressure conditions was required.

The twin screw element's main parts are the male and female rotors, which rotate in opposite directions while the volume between them and the housing decreases. Each screw element has a fixed, build-in pressure ratio that is dependent on its length, the pitch of the screw and the form of the discharge port. To attain maximum efficiency, the build-in pressure ratio must be adapted to the required working pressure.

The screw compressor is generally not equipped with valves and has no mechanical forces that cause unbalance. This means it can work at a high shaft speed and can combine a large flow

rate with small exterior dimensions. An axial acting force, dependent on the pressure difference between the inlet and outlet, must be overcome by the bearings.

2.1.5.1 Oil-free screw compressors

The first twin screw compressors had a symmetric rotor profile and did not use any cooling liquid inside the compression chamber. These were called oil-free or dry screw compressors. Modern, high-speed, oil-free screw compressors have asymmetric screw profiles, resulting in significantly improved energy efficiency, due to reduced internal leakage.

External gears are most often used to synchronize the position of the counter-rotating rotors. As the rotors neither come into contact with each other nor with the compressor housing, no lubrication is required inside the compression chamber. Consequently, the compressed air is completely oil-free. The rotors and housing are manufactured with ultimate precision to minimize leakage from the pressure side to the inlet. The build-in pressure ratio is limited by the limiting temperature difference between the inlet and the discharge. This is why oil-free screw compressors are frequently built with several stages and inter-stage cooling to reach higher pressures.

2:5

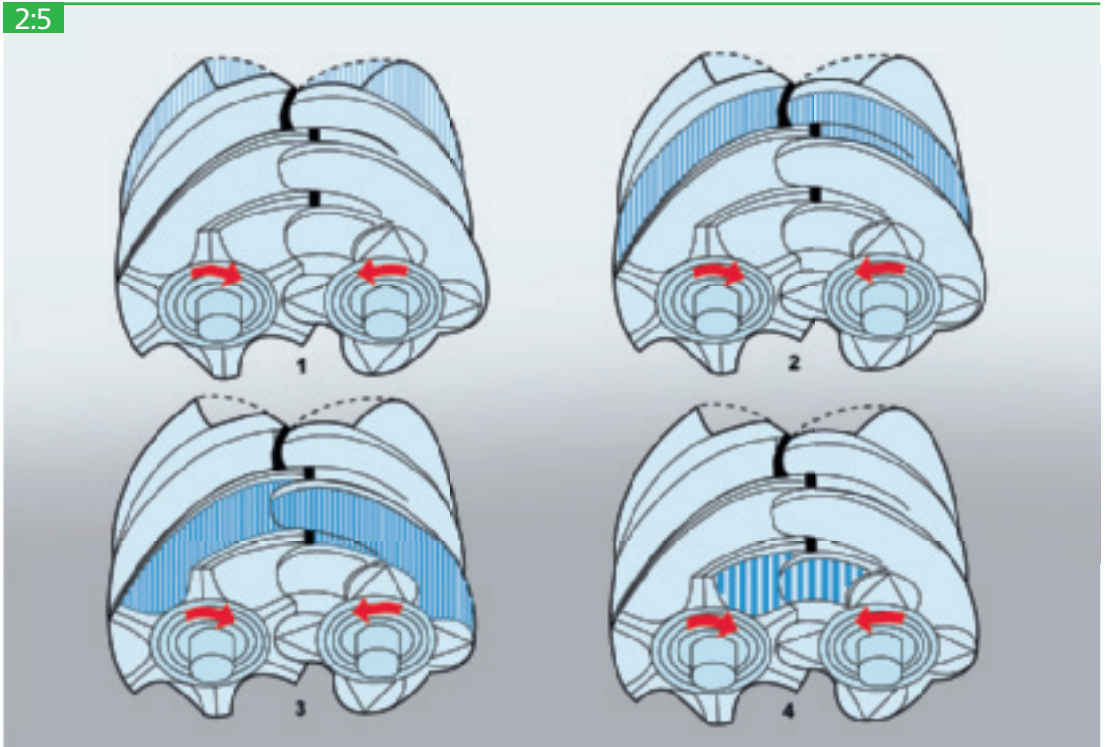

This illustrates compression in a twin screw compressor. Figure 1: air fills the space between the rotors, Fig. 2-4: gradually the enclosed space decreases and pressure increases.

2:6

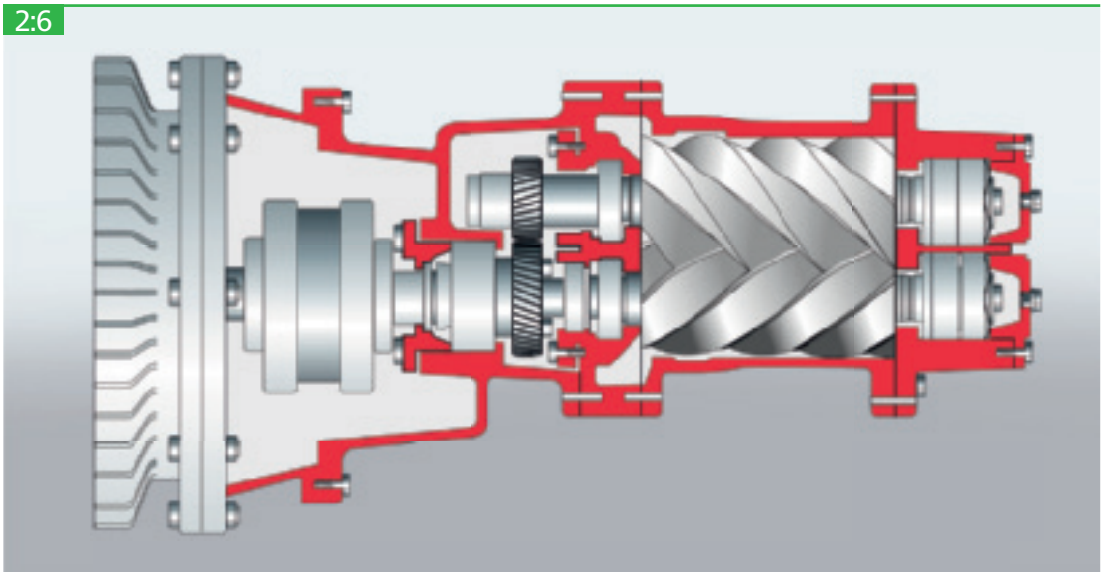

Typical oil lubricated screw compressor element and drive.

2:7

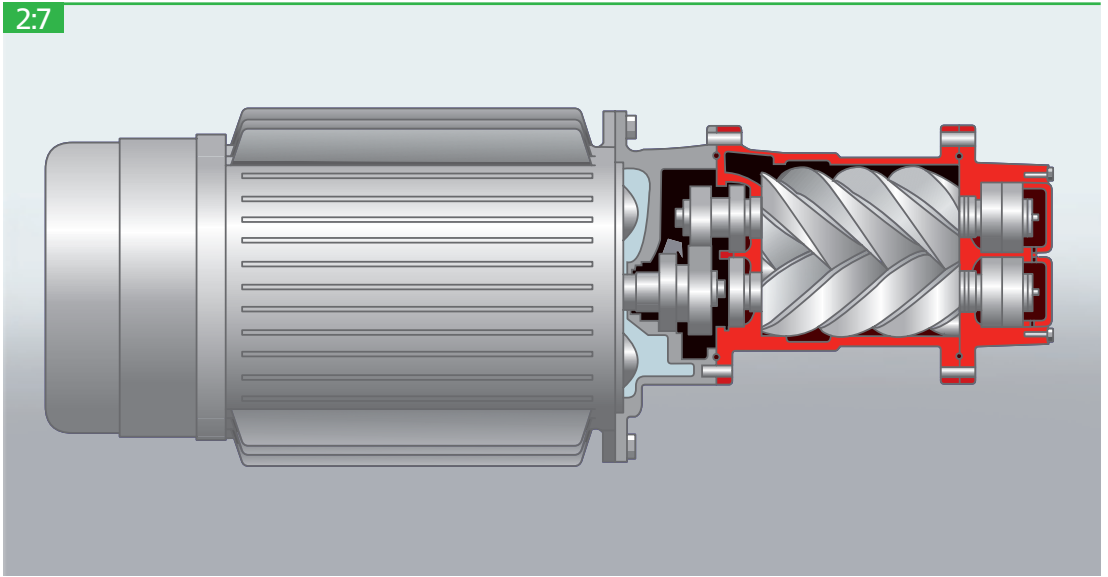

A modern integrated-drive oil-lubricated screw compressor.

2:8

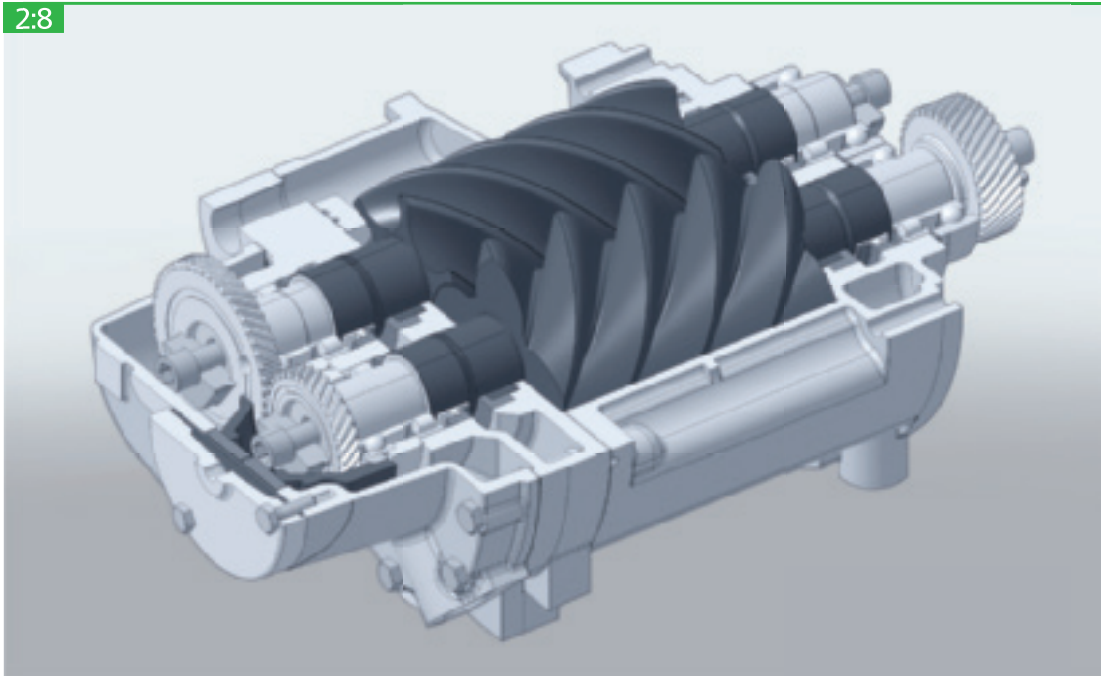

Oil-free screw compressor stage, with water-cooled rotor housing, air seals and oil seals at both ends, and a set of synchronizing gears to maintain the very small rotor clearances.

2.1.5.2 Liquid-injected screw compressors

In liquid-injected screw compressors, a liquid is injected into the compression chamber and often into the compressor bearings. Its function is to cool and lubricate the compressor element's moving parts, to cool the air being compressed internally, and to reduce the return leakage to the inlet.

Today oil is the most commonly injected liquid due to its good lubricating and sealing properties, however, other liquids are also used, for example, water or polymers. Liquid-injected screw compressor elements can be manufactured for high pressure ratios, with one compression stage usually being sufficient for pressure up to 14 and even 17 bar, albeit at the expense of reduced energy efficiency.

2.1.6 Tooth compressors

The compression element in a tooth compressor consists of two rotors that rotate in opposite directions inside a compression chamber.

The compression process consists of intake, compression and outlet. During the intake phase, air is drawn into the compression chamber until the rotors block the inlet. During the compression phase, the drawn in air is compressed in the compression chamber, which gets smaller as the rotors rotate.

The outlet port is blocked during compression by one of the rotors, while the inlet is open to draw in new air into the opposite section of the compression chamber.

2:9

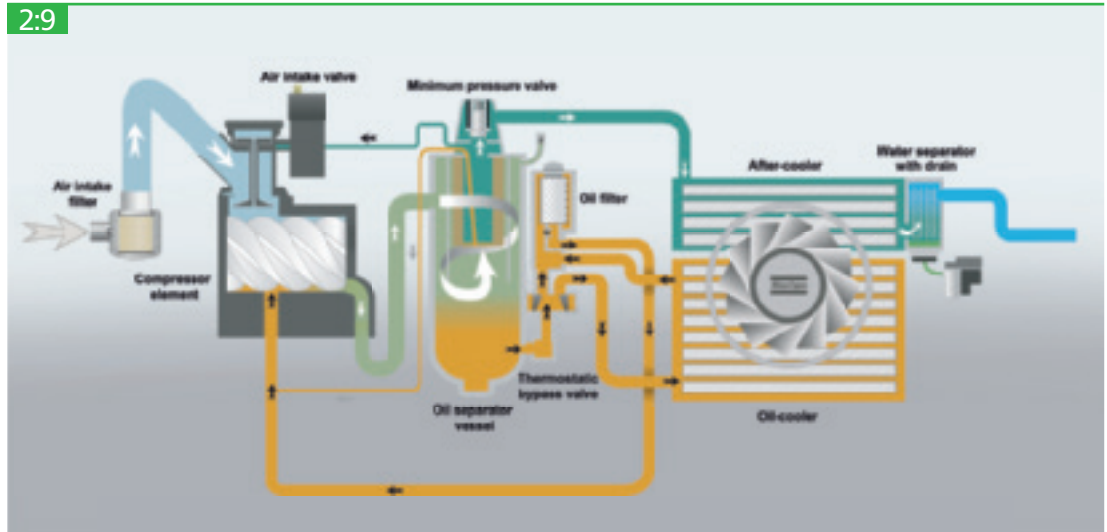

Oil-injected screw compressor flow diagram.

2:10

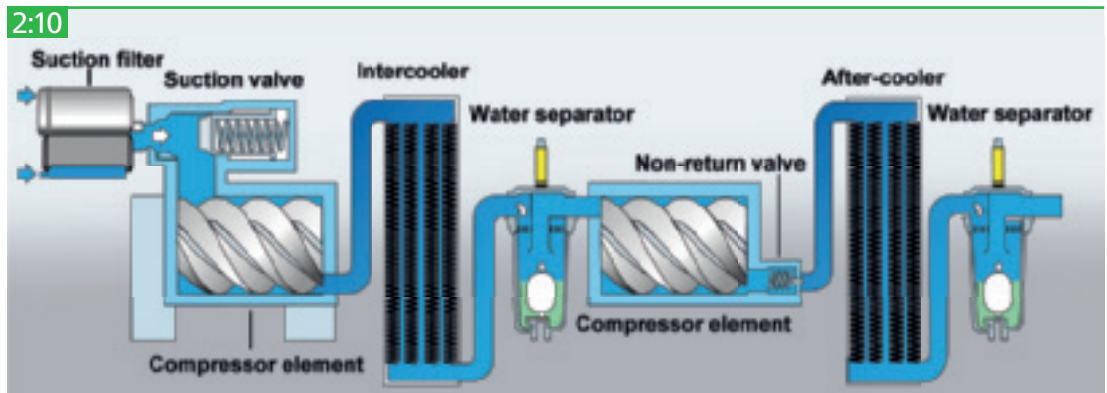

Oil-free screw compressor flow diagram.

2:11

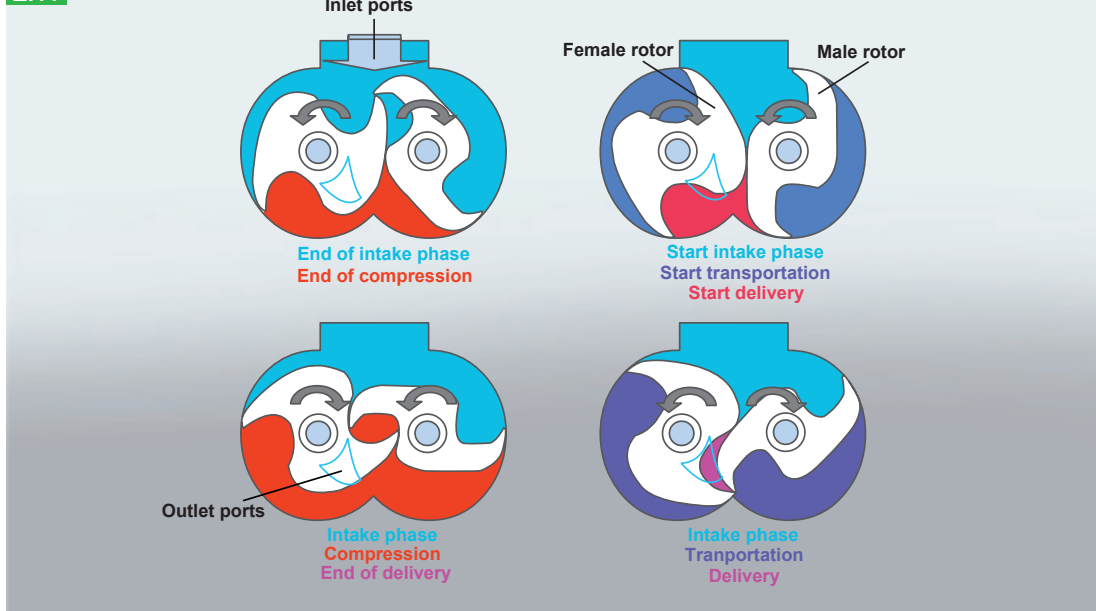

Compression principle of the double tooth compressor.

Discharge takes place when one of the rotors opens the outlet port and the compressed air is forced out of the compression chamber.

Both rotors are synchronized via a set of gear wheels. The maximum pressure ratio obtainable with an oil-free tooth compressor is limited by the limiting temperature difference between the inlet and the discharge. Consequently, several stages with inter-stage cooling are required for higher pressures.

2:12

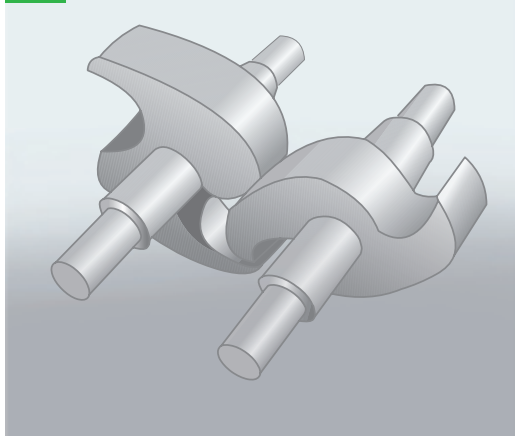

Rotor set of a double tooth compressor.

2.1.7 Scroll compressors

A scroll compressor is a type of (usually) oil-free orbiting displacement compressor, i.e. it compresses a specific amount of air into a continuously decreasing volume. The compressor element consists of a stator spiral fixed in a housing and a motor-driven eccentric, orbiting spiral. The spirals are mounted with 180° phase displacement to form air pockets with a gradually varying volume.

This provides the scroll elements with radial stability. Leakage is minimized because the pressure difference in the air pockets is lower than the pressure difference between the inlet and the outlet.

The orbiting spiral is driven by a short-stroke crankshaft and runs eccentrically around the centre of the fixed spiral. The inlet is situated at the top of the element housing.

When the orbiting spiral moves, air is drawn in and is captured in one of the air pockets, where it is compressed gradually while moving towards the centre where the outlet port and a non-return valve are situated. The compression cycle is in progress for 2.5 turns, which virtually gives constant and pulsation-free air flow. The process is relatively silent and vibration-free, as the element has hardly any torque variation as compared to a piston compressor, for example.

2:13

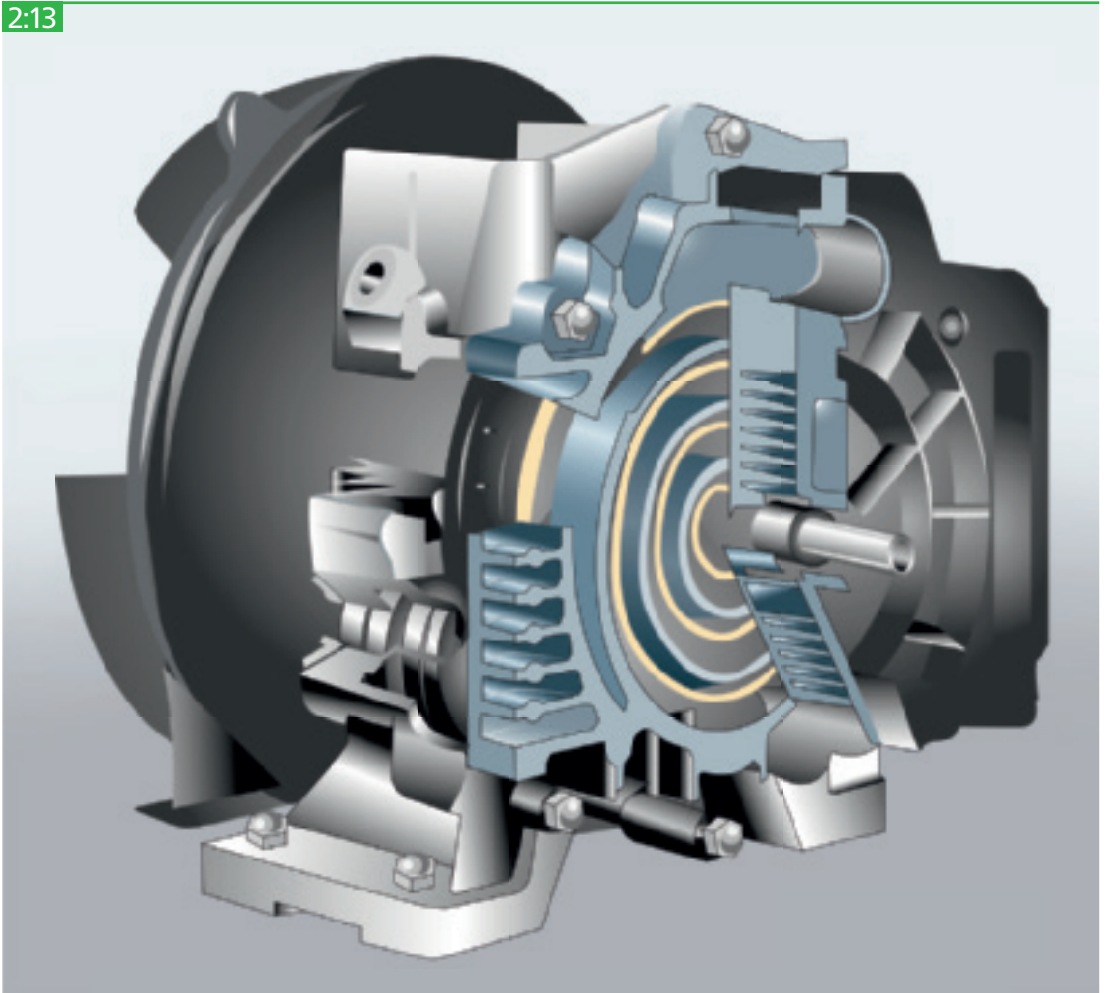

A scroll compressor cross section.

2:14



Compression principle of a scroll compressor.

2.1.8 Vane compressors

The operating principle for a vane compressor is the same as for many compressed air expansion motors. The vanes are usually manufactured of special cast alloys and most vane compressors are oil-lubricated.

A rotor with radial, movable blade-shaped vanes is eccentrically mounted in a stator housing. When it rotates, the vanes are pressed against the stator walls by centrifugal force. Air is drawn in when the distance between the rotor and stator increases. The air is captured in the different compressor pockets, which decrease in volume with rotation. The air is discharged when the vanes pass the outlet port.

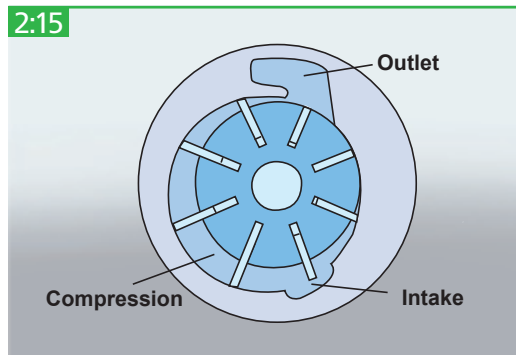

2.1.9 Roots blowers

A Roots blower is a valve-less displacement compressor without internal compression. When the compression chamber comes into contact with the outlet port, compressed air flows back into the housing from the pressure side. Subsequently, further compression takes place when the volume of the compression chamber further decreases with continued rotation. Accordingly, compression takes place against full counter-pressure, which results in low efficiency and a high noise level.

Two identical, usually symmetrical, counter-rotating rotors work in a housing, synchronized by means of a set of gear wheels. Blowers are usually air-cooled and oil-free. Their low efficiency limits these blowers to very low pressure applications and compression in a single stage, even if two- and three-stage versions are available. Roots blowers are frequently used as vacuum pumps and for pneumatic conveyance.

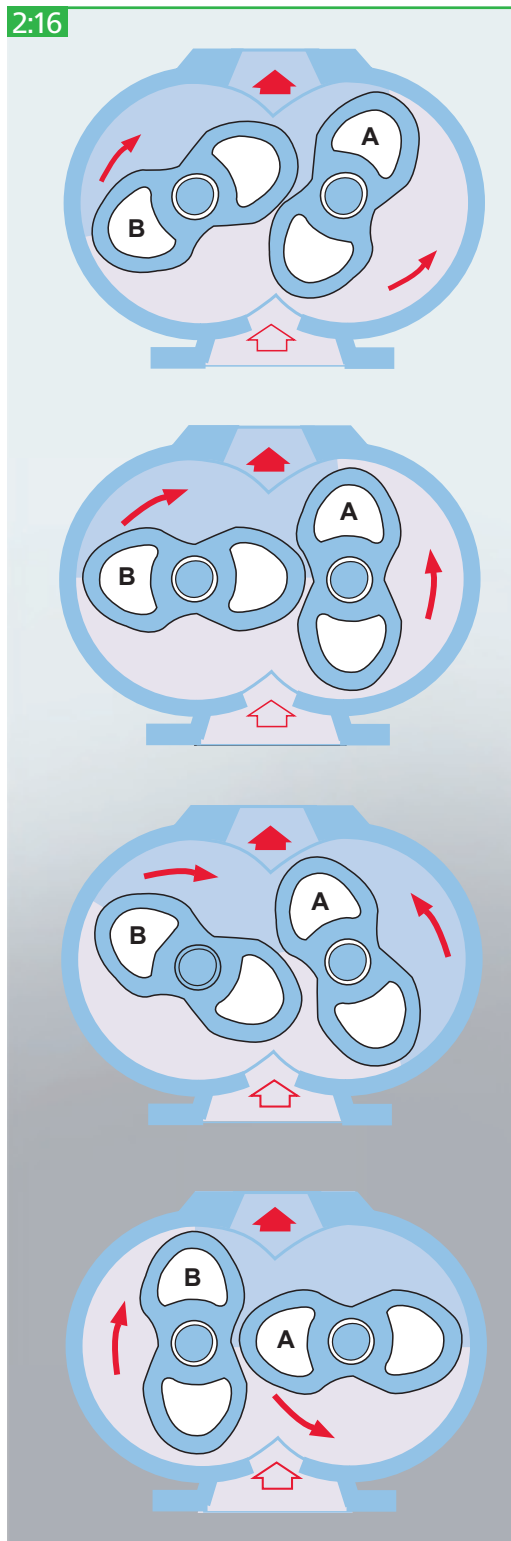

Compression principle of a roots blower.

2.2 DYNAMIC COMPRESSORS

2.2.1 Dynamic compressors in general

Dynamic compressors are available in both axial and radial designs. They are frequently called turbocompressors. Those with radial design are called centrifugal compressors. A dynamic compressor works at a constant pressure, unlike, for example, a displacement compressor, which works with a constant flow. The performance of a dynamic compressor is affected by external conditions: for example, a change in the inlet temperature results in a change in the capacity.

2.2.2 Centrifugal compressors

A centrifugal compressor is characterized by its radial discharge flow. Air is drawn into the centre of a rotating impeller with radial blades and is pushed out towards the perimeter of the impeller by centrifugal forces. The radial movement of

the air results simultaneously in a pressure rise and a generation of kinetic energy. Before the air is led to the centre of the impeller of the next compressor stage, it passes through a diffuser and a volute where the kinetic energy is converted into pressure.

Each stage takes up a part of the overall pressure rise of the compressor unit. In industrial machinery, the maximum pressure ratio of a centrifugal compressor stage is often not more than 3. Higher pressure ratios reduce the stage efficiency. Low pressure, single-stage applications are used, for instance, in wastewater treatment plants. Multi-stage applications allow the possibility of inter-cooling to reduce the power requirement. Multiple stages can be arranged in series on a single, low-speed shaft. This concept is often used in the oil and gas or process industry. The pressure ratio per stage is low, but a large number of stages and/or multiple compressor sets in series are used to achieve the desired outlet pressure. For air compression applications, a high speed gearbox is integrated with the compressor stages to rotate the impellers on high speed pinions.

2:17

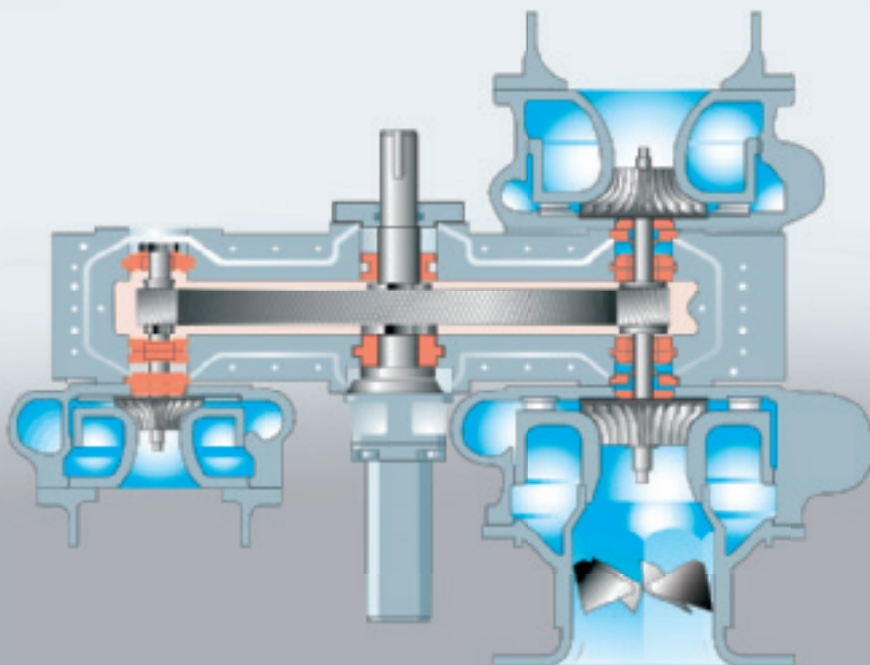

Three-stage integral gear centrifugal compressor.

2:18

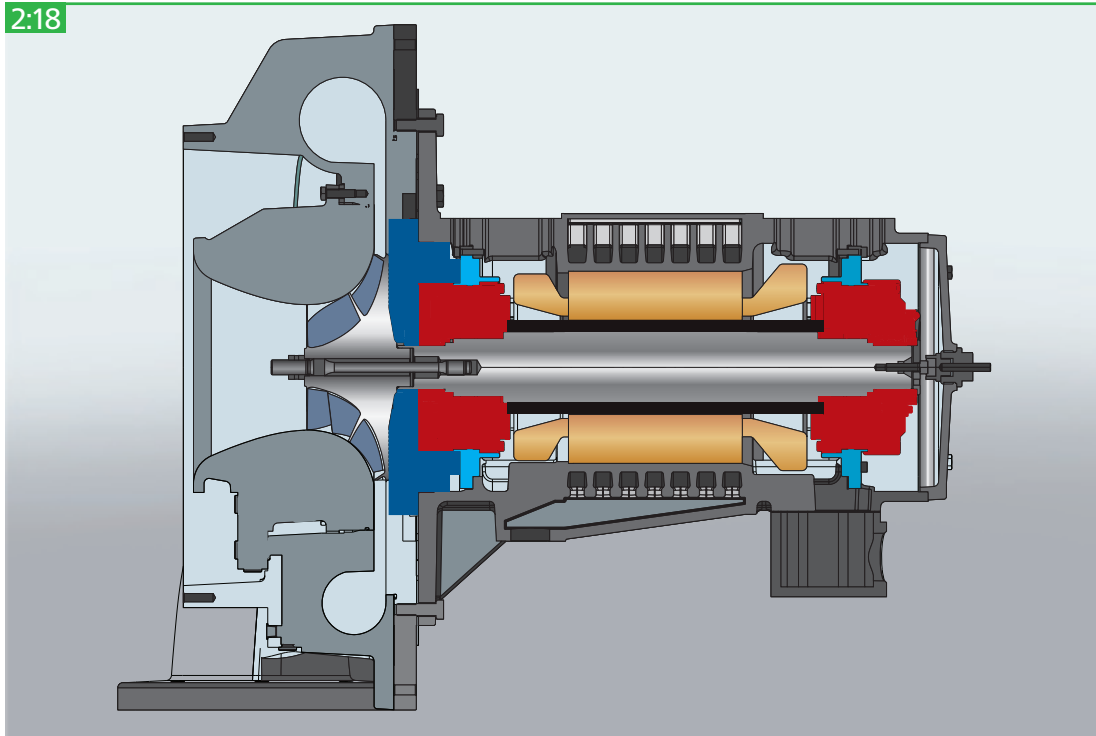

Modern high-speed direct-drive centrifugal compressor.

The impeller can have either an open or closed design. Open design is most commonly used for high speed air applications. The impeller is normally made of special stainless steel alloy or aluminum. The impeller shaft speed is very high compared to that of other types of compressor. Speeds of 15,000-100,000 rpm are common. This means that journaling on the high speed compressor shaft or pinion takes place using

plain oil-film bearings instead of roller bearings. Alternatively, air film bearings or active magnetic bearings can be used for a completely oil-free machine.

Two impellers are mounted on each end of the same shaft to counteract the axial loads caused by the pressure differences. Typically 2 or 3 stages with intercoolers are used for standard compressed air applications.

In a modern configuration of the centrifugal air compressor, ultra-high speed electric motors are used to drive the impellers directly. This technology creates a compact compressor without a gearbox and associated oil-lubrication system, thereby making it a completely oil-free compressor design.

Each centrifugal compressor must be sealed in a suitable manner to reduce leakage along the shaft where it passes through the compressor housing. Many types of seals are used and the most advanced can be found on high-speed compressors intended for high pressures. The most common types are labyrinth seals, ring seals or controlled gap seals, (usually graphite seals) and mechanical seals.

2:19

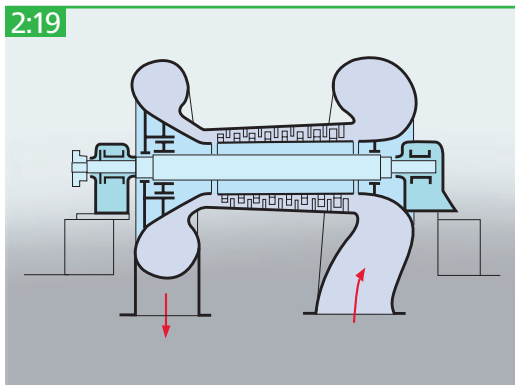

Axial compressor.

2.2.3 Axial compressors

An axial compressor has axial flow, whereby the air or gas passes along the compressor shaft through rows of rotating and stationary blades. In this way, the velocity of the air is gradually increased at the same time that the stationary blades convert the kinetic energy to pressure. A balancing drum is usually built into the compressor to counterbalance axial thrust.

Axial compressors are generally smaller and lighter than their equivalent centrifugal compressors and normally operate at higher speeds. They are used for constant and high volume flow rates at a relatively moderate pressure, for instance, in ventilation systems. Given their high rotational speed, they are ideally coupled to gas turbines for electricity generation and aircraft propulsion.

2.3 OTHER COMPRESSORS

2.3.1 Vacuum pumps

A vacuum signifies a pressure lower than atmospheric pressure. A vacuum pump is a compressor that compresses a vacuum to higher pressures, generally to atmospheric pressure. A typical characteristic of a vacuum pump is that it works

2:21

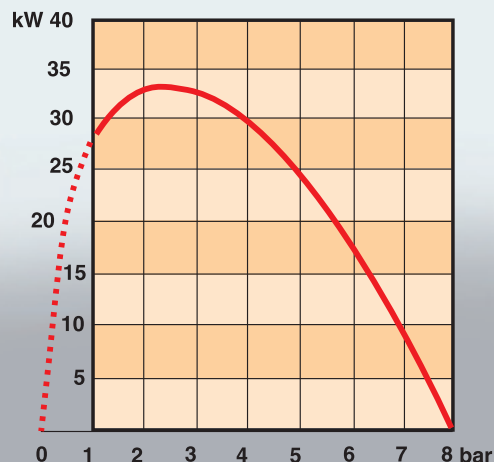

Adiabatic power requirement for a booster compressor with an absolute final pressure of 8 bar(a).

with a very high pressure ratio. This explains why multi-stage machines are common. Multi-stage air compressors can also be used for vacuums within the pressure range 1 bar(a) and 0.1 bar(a).

2.3.2 Booster compressors

A booster compressor is a compressor that compresses compressed air to a much higher pressure. It may be used to compensate the pressure drop in long pipelines or for applications in which a higher pressure is required for a sub-pro-

2:20

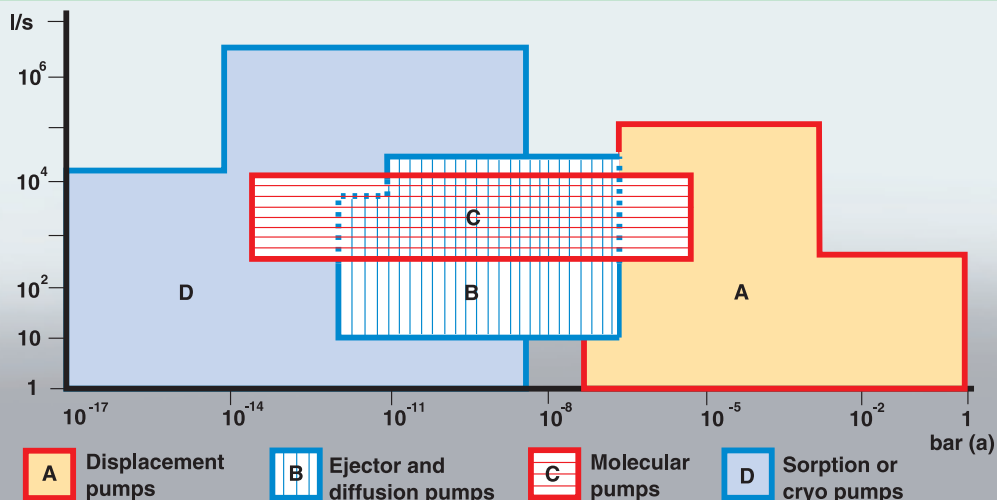

Working range for some types of vacuum pumps.

cess. Booster compressors may be single-stage or multi-stage and can be of a dynamic or displacement type, but piston compressors are the most common. The power requirement for a booster compressor increases as the pressure ratio rises, whereas the mass flow drops. The curve for power requirement as a function of the inlet pressure has the same general form as the curve for a vacuum pump.

2.3.3 Pressure intensifiers

Pressure intensifiers are a form of booster compressors, driven by the compressed air medium itself (called the propellant). They can increase the pressure in a medium for special applications: for laboratory tests of valves, pipes and hoses. A pressure of 7 bar can be amplified in a single stage to 200 bar or up to 1700 bar in multi-

staged equipment. The pressure intensifier is only available for very small flows.

When the propellant flows in, the low-pressure piston is pressed downwards and forces the medium in the high-pressure compression chamber out under high pressure. The intensifier can work in a cycling process, up to a preset pressure level. All inert gases can be compressed in this way. Air can also be compressed in a pressure intensifier, but must be completely oil-free to avoid self-ignition.

2.4 TREATMENT OF COMPRESSED AIR

2.4.1 Drying compressed air

All atmospheric air contains water vapor: more at high temperatures and less at lower temperatures. When the air is compressed the water concentration increases. For example, a compressor with a working pressure of 7 bar and a capacity of 200 l/s that compresses air at 20°C with a relative humidity of 80% will release 10 liters/hour of water in the compressed air line. To avoid problems and disturbances due to water precipitation in the pipes and connected equipment, the compressed air must be dried. This takes place using an after-cooler and drying equipment.

The term "pressure dew point" (PDP) is used to describe the water content in the compressed air. It is the temperature at which water vapor condenses into water at the current working pressure. Low PDP values indicate small amounts of water vapor in the compressed air.

It is important to remember that atmospheric dew point can not be compared with PDP when comparing different dryers. For example, a PDP of +2°C at 7 bar is equivalent to -23°C at atmospheric pressure. To use a filter to remove moisture (lower the dew point) does not work. This is because further cooling leads to continued precipitation of condensation water. You can select the main type of drying equipment based on the pressure dew point. When taking cost into account, the lower the dew point required, the higher the investment and operating costs for air drying. Five techniques exist for removing the

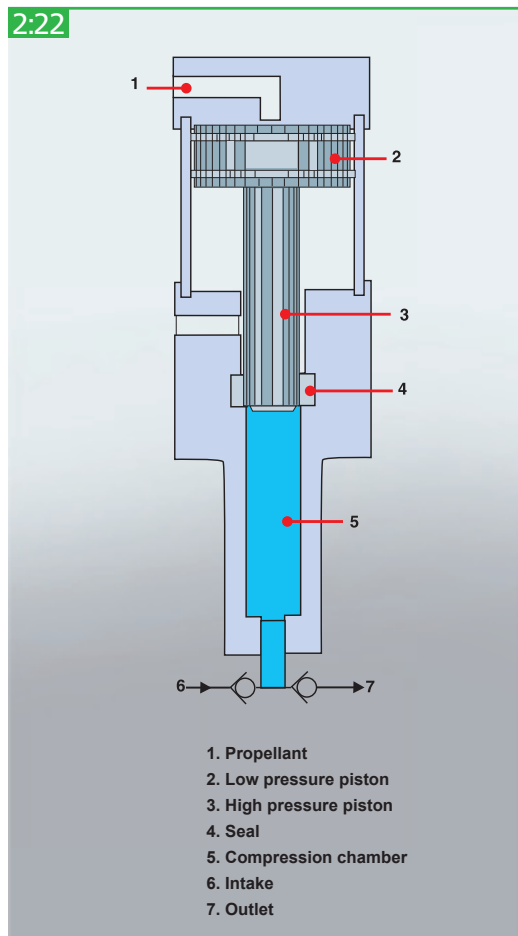

A cross section of a single stage pressure intensifier.

2:23

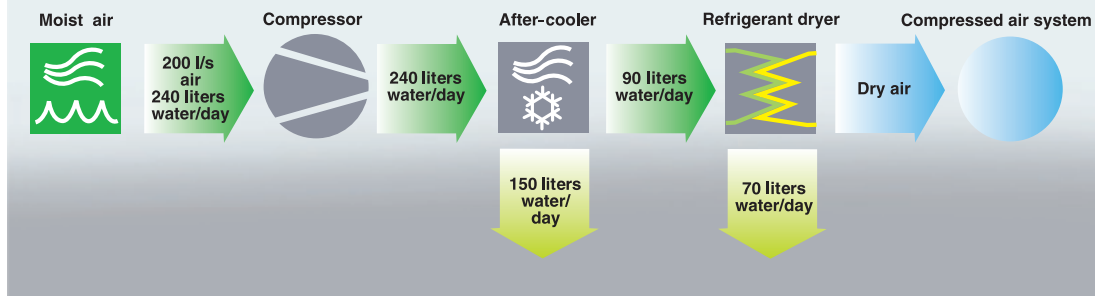

A compressor that delivers 200 liters/second of air also supplies approx. 10 liters/hour of water when compressing air at 20°C. Problems due to water precipitation in the pipes and equipment are avoided by the use of after-cooler and drying equipment.

2:24

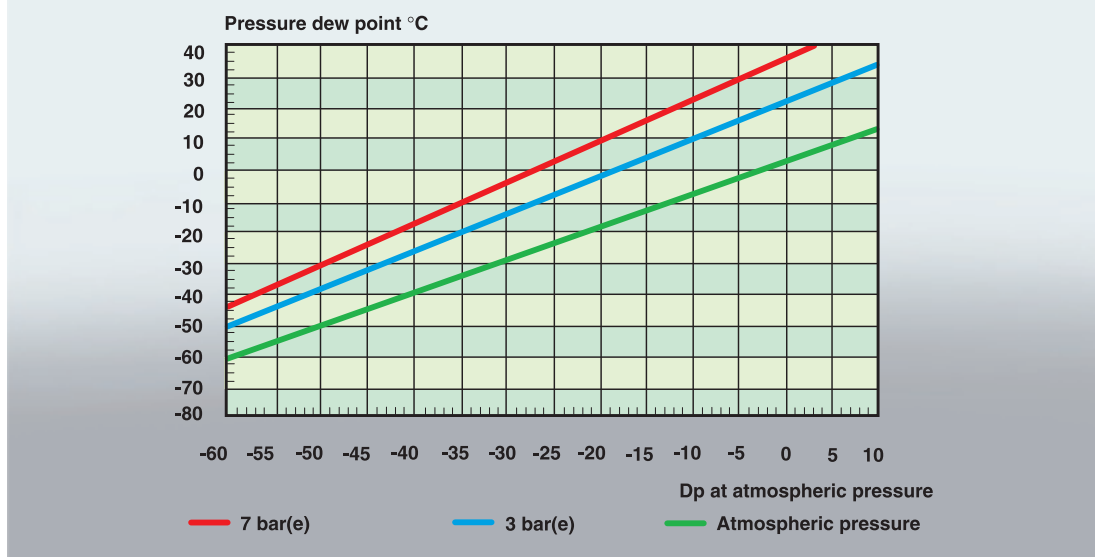

Relation between dew point and pressure dew point.

moisture from compressed air: cooling plus separation, over-compression, membranes, absorption and adsorption drying.

2.4.1.1 After-cooler

An after-cooler is a heat exchanger that cools the hot compressed air to precipitate the water that otherwise would condensate in the pipe system. It is water-cooled or air-cooled, is generally equipped with a water separator with automatic drainage and should be placed close to the compressor.

Approximately 80–90% of the precipitated condensation water is collected in the after-cooler's water separator. A common value for the temperature of the compressed air after passing through the after-cooler is approx. 10°C above the coolant temperature, but can vary depending on the type of cooler. An after-cooler is used in virtually all stationary installations. In most cases, an after-cooler is built into modern compressors.

2:25

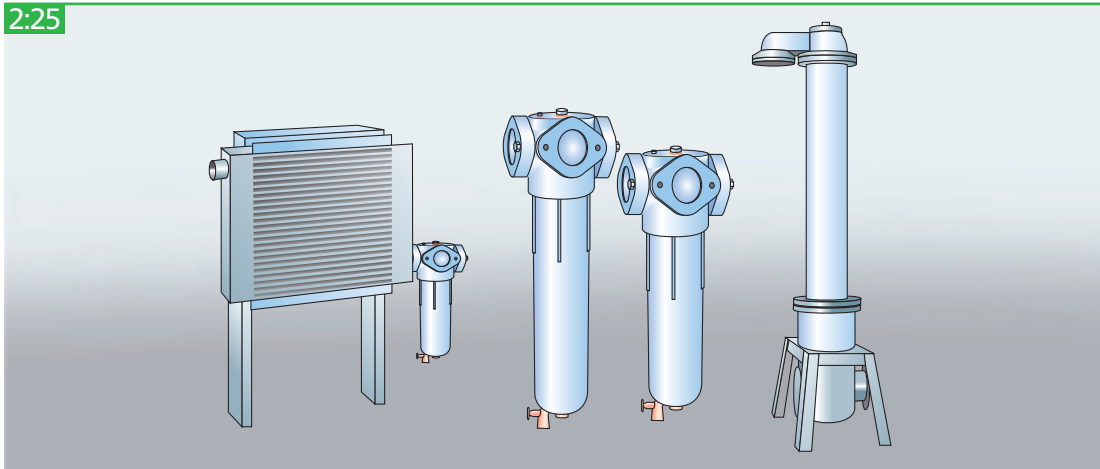

Different after-coolers and water separators. Water separators can work with cyclone separating or separation through changes in direction and speed.

2.4.1.2 Refrigerant dryer

Refrigerant drying means that the compressed air is cooled, which allows a large amount of the water to condense and be separated. After cooling and condensing, the compressed air is reheated to around room temperature so that condensation does not form on the outside of the pipe system. This heat exchange between ingoing and outgoing compressed air also reduces the temperature of the incoming compressed air, and as such reduces the required cooling capacity of the refrigerant circuit.

Cooling the compressed air takes place via a closed refrigerant system. Smart steering of the refrigerant compressor via intelligent control algorithms can significantly reduce the power consumption of modern refrigerant dryers. Refrigerant dryers are used for dew points between +2°C to +10°C and have a lower limit, which is the freezing point of the condensed water. They are available as either a freestanding machine or an integrated drying module inside the compressor. The latter has the advantage of having a small footprint and ensures optimized performance for the particular air compressor capacity.

Modern refrigerant dryers use refrigerant gases with a low Global Warming Potential (GWP), which means refrigerant gases that -when accidentally released into the atmosphere-

contribute less to global warming. Future refrigerants will have an even lower GWP value, as dictated by environmental legislation.

2:26

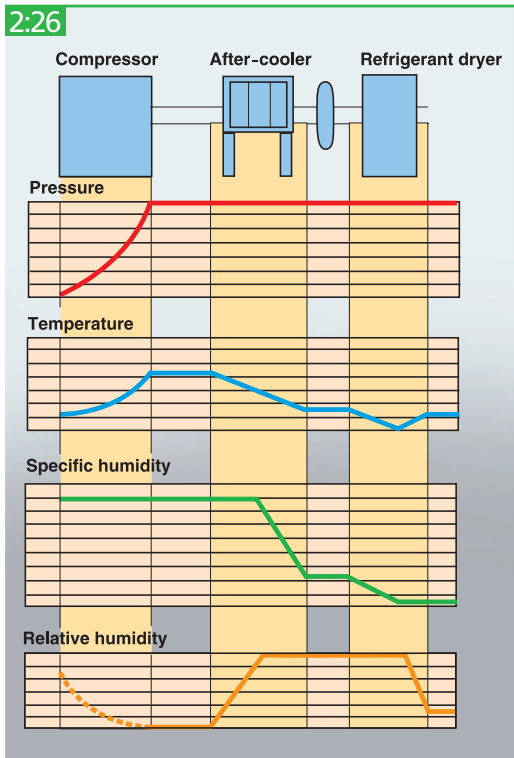

Typical parameter changes with compression, after-cooling and refrigerant drying.

2:27

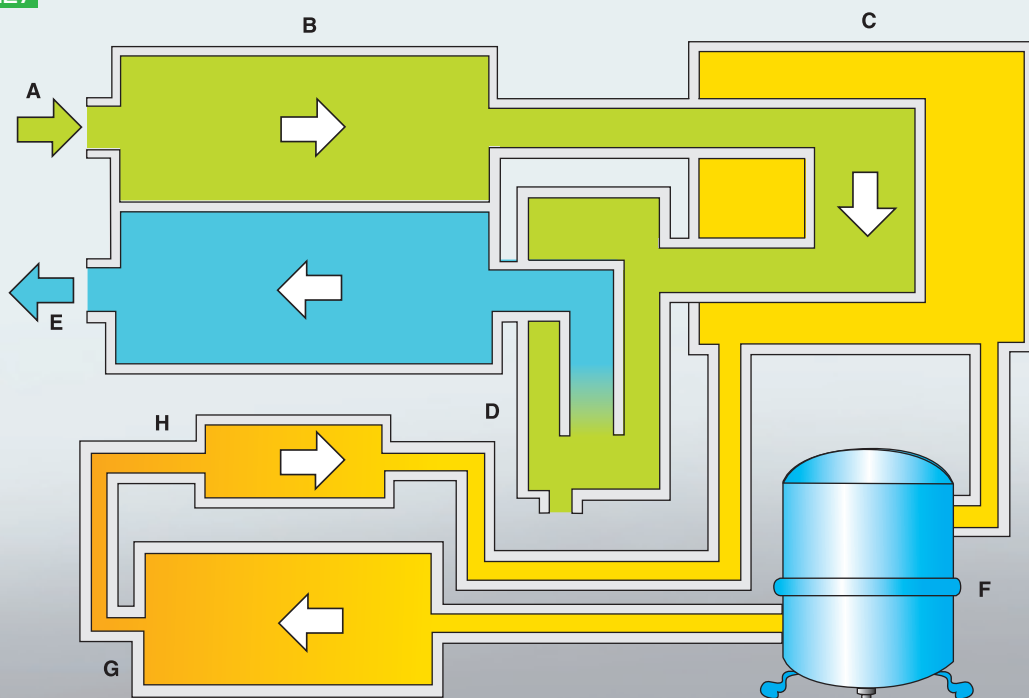

A Incoming compressed air
 B Air/air heat exchanger
 C Air/coolant heat exchanger
 D Water separator

E Dry compressed air
 F Compressor
 G Condenser
 H Expansion valve

Operational principle of refrigerant drying.

2.4.1.3 Over-compression

Over-compression is perhaps the easiest method for drying compressed air.

Air is first compressed to a higher pressure than the intended working pressure, which means that the concentration of water vapor increases. Thereafter the air is cooled and the water is separated as a result. Finally, the air is allowed to expand to the working pressure, and a lower PDP is attained. However, this method is only suitable for very small air flow rates, due to its high energy consumption.

2.4.1.4 Absorption drying

Absorption drying is a chemical process in which water vapor is bound to absorption material. The absorption material can either be a solid or

liquid. Sodium chloride and sulfuric acid are frequently used, which means that the possibility of corrosion must be taken into consideration. This method is unusual and involves high consumption of absorbent materials. The dew point is only lowered to a limited extent.

2.4.1.5 Adsorption drying

The general working principle of adsorption dryers is simple: moist air flows over hygroscopic material (typical materials used are silica gel, molecular sieves, activated alumina) and is thereby dried.

The exchange of water vapor from the moist compressed air into the hygroscopic material or "desiccant", causes the desiccant to gradually be saturated with adsorbed water. Therefore, the

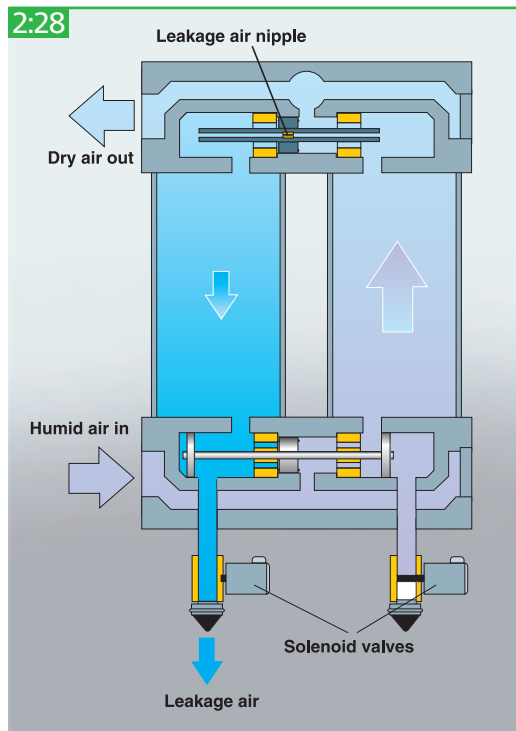

Purge regenerated adsorption dryer (also called “heatless type dryer”).

desiccant needs to be regenerated regularly to regain its drying capacity, and adsorption dryers are typically built with two drying vessels for that purpose: the first vessel will dry the incoming compressed air while the second one is being regenerated. Each vessel (“tower”) switches tasks when the other tower is completely regenerated. Typical PDP that can be achieved is -40°C , which makes these dryers suitable for providing very dry air for more critical applications.

There are 4 different ways to regenerate the desiccant, and the method used determines the type of adsorption dryer. More energy-efficient types are usually more complex and, consequently, more expensive.

1) Purge regenerated adsorption dryers (also called “heatless-type dryers”).

These dryers are best suited for smaller air flow rates. The regeneration process takes place with the help of expanded compressed air (“purged”) and requires approx. 15–20% of the dryer’s nominal capacity at 7 bar(e) working pressure.

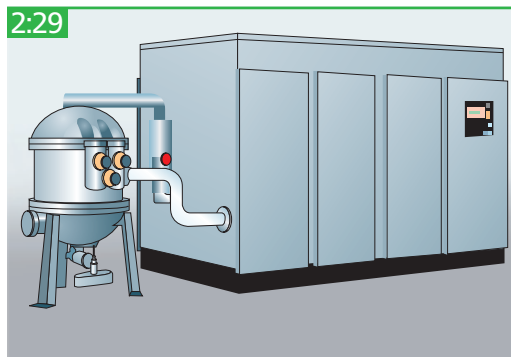

Oil-free screw compressor with a MD model adsorption dryer.

2) Heated purge regenerated dryers.

These dryers heat up the expanded purge air by means of an electric air heater and hence limit the required purge flow to around 8%. This type uses 25% less energy than heatless-type dryers.

3) Blower regenerated dryers.

Ambient air is blown over an electric heater and brought into contact with the wet desiccant in order to regenerate it. With this type of dryer, no compressed air is used to regenerate the desiccant material, thus the energy consumption is 40% lower than for heatless-type dryers.

4) Heat of compression dryers (“HOC” dryers).

In HOC dryers the desiccant is regenerated by using the available heat of the compressor. Instead of evacuating the compressed air heat in an after-cooler, the hot air is used to regenerate the desiccant.

This type of dryer can provide a typical PDP of -20°C without any energy being added. A lower PDP can also be obtained by adding extra heaters.

Guaranteed separation and drainage of the condensation water must always be arranged before adsorption drying. If the compressed air has been produced using oil-lubricated compressors, an oil separating filter must also be fitted upstream of the drying equipment. In most cases a particle filter is required after adsorption drying. HOC dryers can only be used with oil-free compressors since they produce heat at sufficiently high temperatures for dryer regeneration.

2:30

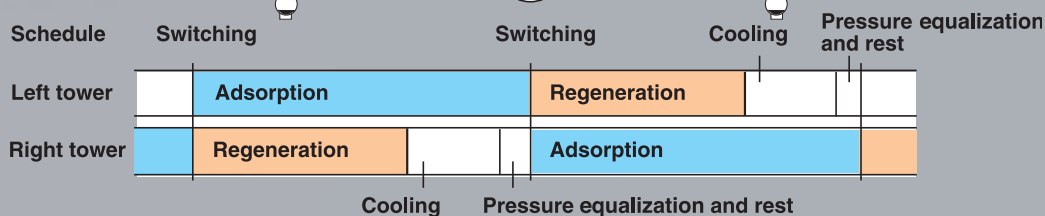
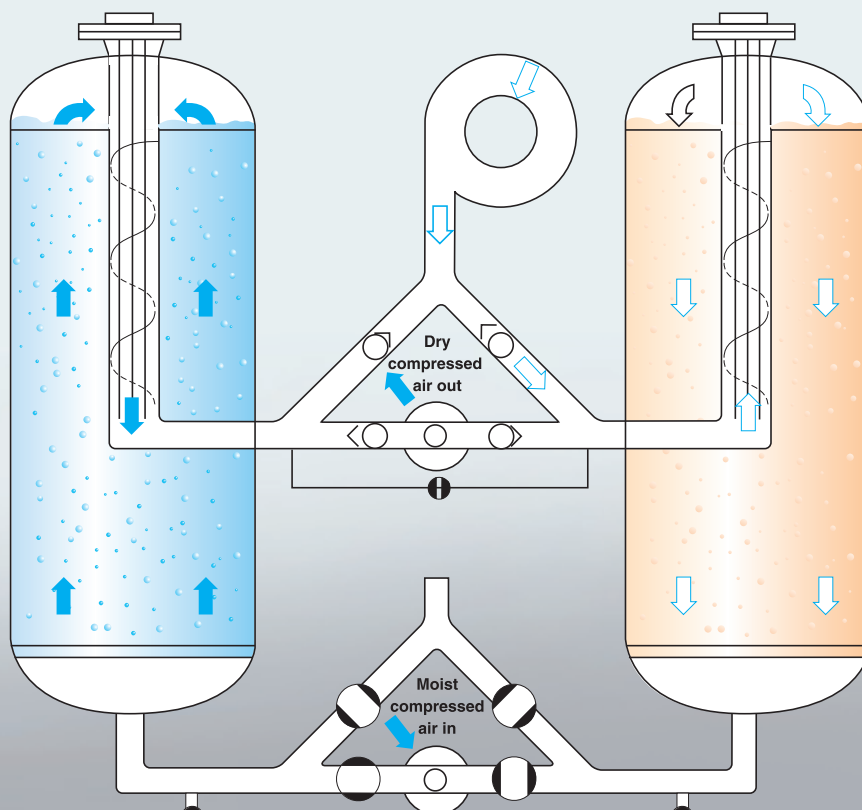

Blower regenerated dryer. The left tower is drying the compressed air while the right tower is regenerating. After-cooling and pressure equalization the towers are automatically switched.

A special type of HOC dryer is the rotary drum adsorption dryer. This type of dryer has a rotating drum filled with desiccant of which one sector (a quarter) is regenerated by means of a partial flow of hot compressed air (at 130–200°C) from the compressor. Regenerated air is subsequently cooled, the condensation is drained and the air is returned via an ejector device into the main compressed air flow. The rest of the drum surface (three-quarters) is used to dry the compressed air coming from the compressor after-cooler.

A HOC dryer avoids compressed air loss, and the power requirement is limited to that required for rotating the drum. For example, a dryer with a capacity of 1000 l/s only consumes 120 W of electrical power. In addition, no compressed air is lost and neither oil filters nor particle filters are required.

2:31

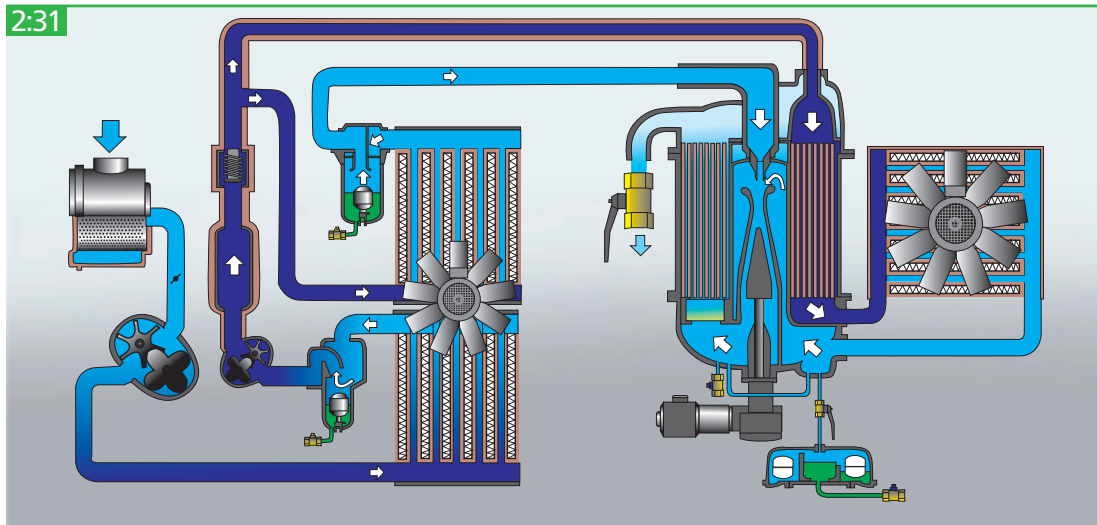

Heat of Compression (HOC) type dryer – MD model with rotating drum.

2.4.1.6 Membrane dryers

Membrane dryers use the process of selective permeation of the gas components in the air. The dryer is a cylinder which houses thousands of tiny hollow polymer fibers with an inner coating. These fibers have selective permeation for the removal of water vapor. As filtered, wet compressed air enters the cylinder, the membrane coating allows water vapor to permeate the membrane wall and collect between the fibers, while the dry air continues through the fibers in the cylinder at almost the same pressure as the incoming wet air. The permeated water is vented to the atmosphere outside of the cylinder.

The permeation or separation is caused by the difference in the partial pressure of a gas between the inside and the outside of the hollow fiber. Membrane dryers are simple to operate, silent while operating, have no moving parts, low

power consumption and minimal service requirements (mainly filters upstream of the dryer).

Besides removing water, gas component separation can also be achieved with a membrane, depending on the characteristics of the fiber material. Separation of different gases is achieved by differences in molecular size and gas solubility in the membrane. Gases of smaller molecular size have larger diffusion and can be suitably separated by differences in mobility. As such, specific membranes can be used to make nitrogen generators, for example.

2.4.2 Filters

Particles in an air stream that pass through a filter can be removed in several different ways. If the particles are larger than the openings between the filter material they are separated mechanically (“sieving”). This usually applies for particles larger

2:32

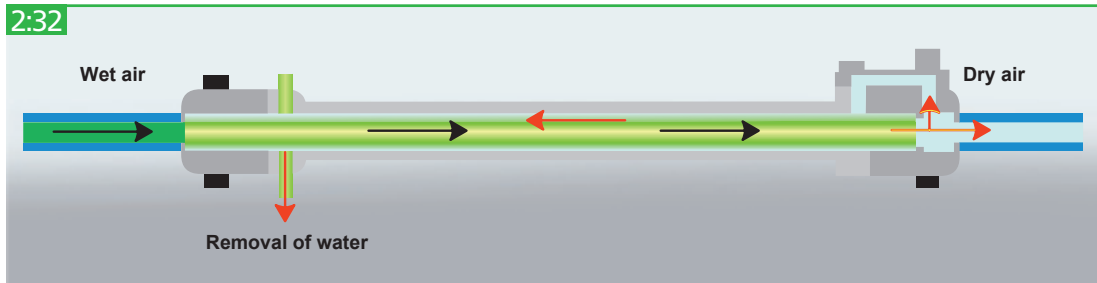

Working principle of membrane dryers.

2:33

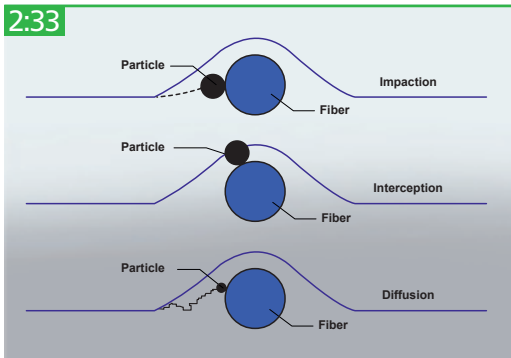

Particle collision mechanisms in filters.

than 1 mm. The filter efficiency in this regard increases with a tighter filter material, consisting of finer fibers.

Particles smaller than 1 mm are collected on fiber material by 3 physical mechanisms: inertial impaction, interception and diffusion.

Impaction occurs for relatively large particles and/or for high gas velocities. Due to the large inertia of the heavy particle, it does not follow the streamlines but instead travels straight ahead and collides with the fiber. This mechanism mainly occurs for particles above $1\mu\text{m}$ and becomes increasingly important with the increasing size of the particles.

Interception occurs when a particle does follow the streamline, but the radius of the particle is larger than the distance between the streamline and the fiber perimeter.

Particle deposition due to diffusion occurs when a very small particle does not follow the streamlines but moves randomly across the flow due to Brownian motion. It becomes increasingly important with smaller particle size and lower air velocity.

The particle-separating capacity of a filter is a result of the combined sub-capacities (for the different particle sizes) as set forth above. In reality, each filter is a compromise, as no filter is efficient across the entire particle size range. Even the effect of the stream velocity on the separating capacity for different particle sizes is not a decisive factor. Generally, particles between $0.1\mu\text{m}$ and $0.2\mu\text{m}$ are the most difficult to separate (Most Penetrating Particle Size).

As stated above, the total capturing efficiency of a coalescence filter can be attributed to a combination of all occurring mechanisms. Obviously, the importance of each mechanism, the particle sizes for which they occur and the value of the total efficiency heavily depend on the particle size distribution of the aerosol, the air speed and the fiber diameter distribution of the filter media.

Oil and water in aerosol form behave similar to other particles and can also be separated using a coalescing filter. In the filter these liquid aerosols coalesce to larger droplets that sink to the bottom of the filter due to gravitational forces. The

2:34

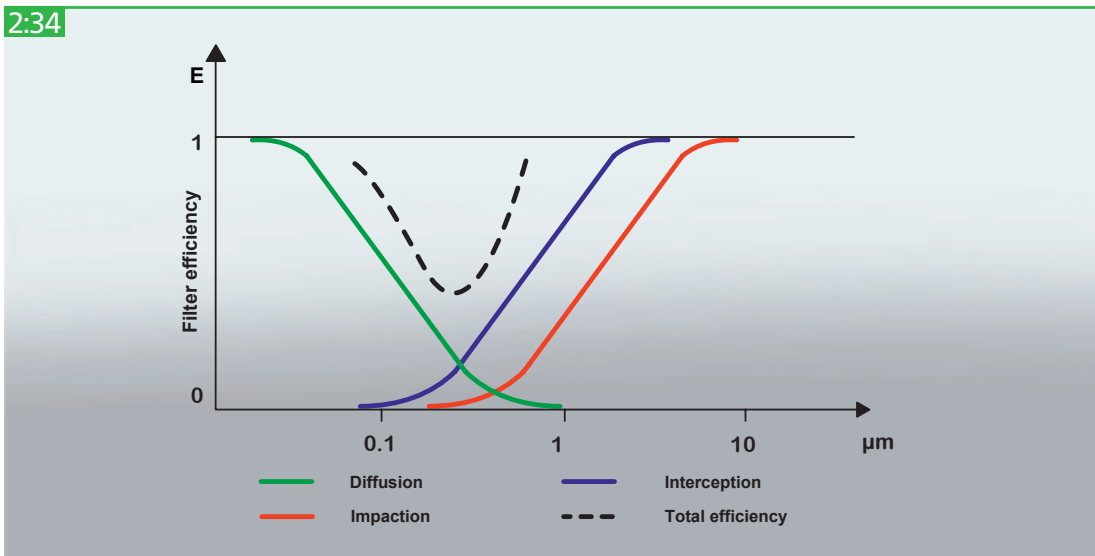

Filter efficiency as a function of particle size.

2:35

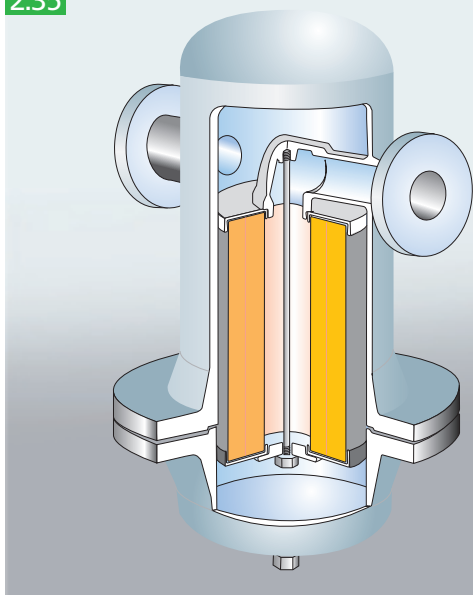

This is how a particle filter may look in reality. A large filter housing and large area mean a low air velocity, less pressure drop and a longer service life.

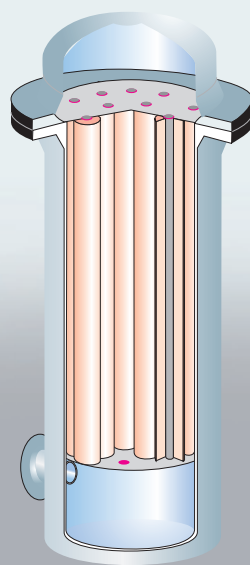

A filter to remove oil, water and dust particles.

filter can separate oil in aerosol as well as in liquid form. However, oil in liquid form will, due to the inherent high concentration, result in high pressure drop and oil carry-over. If oil in vapor form is to be separated, the filter must contain a suitable adsorption material, usually activated carbon (see also section 3.2.5).

All filtering inevitably results in a pressure drop, which is an energy loss in the compressed air system. Finer filters with a tighter structure cause a higher pressure drop and may get clogged more quickly, which demands more frequent filter replacement and consequently higher maintenance costs.

The quality of the air in regards of the amount of particles and the presence of water and oil is defined in ISO 8573-1, the industry standard for air purity (see section 3.2). To eliminate the risk of air contamination in a critical process, it is recommended that only compressed air classified as Class 0 be used.

Additionally, filters must be dimensioned so that they not only handle the nominal flow properly, but also have a larger capacity threshold in order to manage some pressure drop due to a certain amount of blockage.

2.5 CONTROL AND REGULATION SYSTEMS

2.5.1 Regulation in general

Frequently, applications require constant pressure in the compressed air system. This, in turn, requires that the compressed air flow from the compressor center in order to be regulated. There are a number of flow regulation methods available, depending on the type of compressor, acceptable pressure variations, air consumption variations and acceptable energy losses.

Energy consumption represents approximately 80% of the total life cycle cost for compressed air, which means that the choice of a regulation system must be made carefully. This is primarily due to significant differences in performance broadly with regard to compressor types or manufacturers. In an ideal case scenario, the compressor's full capacity could be precisely matched to its air consumption, for example, by carefully choosing the gearbox's transmission ratio (as this is something that is frequently used in process applications.)

2:36

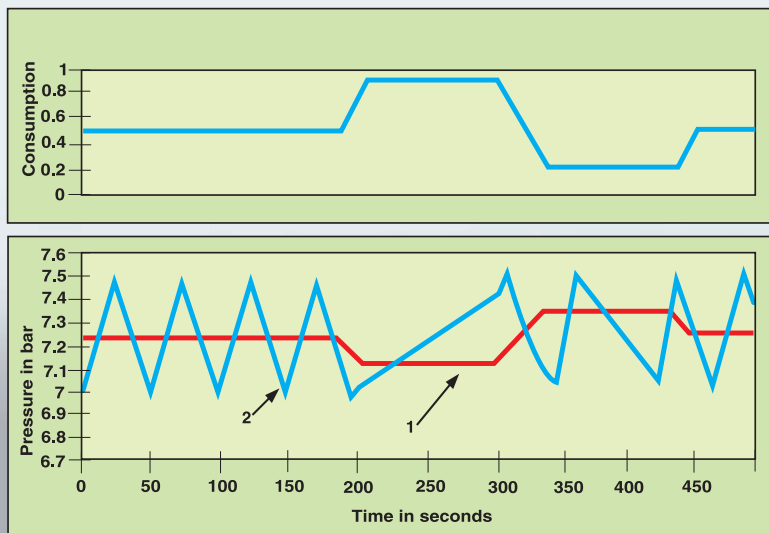

1. Continuous capacity regulation 2. Load/unload regulation

A number of applications are self-regulating, i.e. increased pressure creates an increased flow rate, and as a result, stable systems. Examples include pneumatic conveying systems, ice prevention, chilling systems etc. However, in most applications, the flow rate must be regulated. This is usually performed using regulation equipment that is integrated in the compressor. There are two main groups of regulation systems:

1. Continuous flow rate regulation involves the continuous control of the drive motor or inlet valve according to variations in pressure. The result is normally small pressure variations (0.1 to 0.5 bar), depending on the regulation system's amplification and its regulating speed.
2. Load/unload regulation is the most common regulation method and involves the acceptance of somewhat larger variations in pressure between two limit values. This takes place by completely stopping the flow rate at the higher pressure (off-loading) and resuming the flow rate (loading) when the pressure has dropped to the lowest limit value. Pressure variations depend on the permitted number of load/unload cycles per time unit, but normally lie within the 0.3 to 1 bar range.

2.5.2 Regulation principles for displacement compressors

2.5.2.1 Pressure relief

The original method for regulating compressors was to use a pressure relief valve to release excess air pressure into the atmosphere. The valve in its simplest design can be spring-loaded, whereby the spring tension determines the final pressure. Frequently a servo-valve controlled by a regulator is used instead. The pressure can then be easily controlled and the valve can also act as an off-loading valve when starting a compressor under pressure. Pressure relief creates a significant energy requirement, as the compressor must work continuously against full counterpressure. A variant, which is used on smaller compressors, is to unload the compressor by fully opening the valve so that the compressor works against atmospheric pressure. Power consumption is significantly lower using this variant method.

2:37

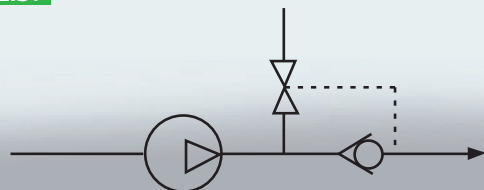

2.5.2.2 Bypass

Bypass regulation serves the same function as pressure relief, in principle. The difference lies in the fact that the pressure relieved air is cooled and returned to the compressor's inlet. This method is often used on process compressors where the gas is unsuitable or too valuable to be released into the atmosphere.

2:38

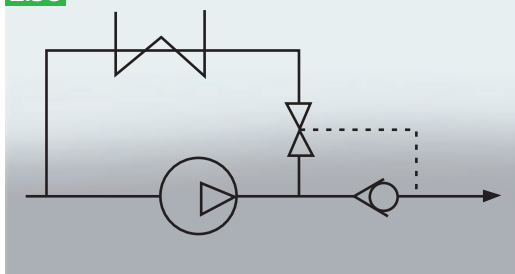

2.5.2.3 Throttling the inlet

Throttling is a simple method to reduce flow by increasing the pressure ratio across the compressor, according to the induced under-pressure in the inlet. This method is, however, limited to a small regulation range. Liquid-injected compressors, which can overcome such a high pressure ratio, can be regulated down to 10% of maximum capacity. The throttling method creates a relatively high energy requirement, due to the high pressure ratio.

2:39

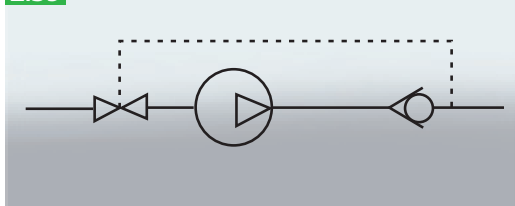

2.5.2.4 Pressure relief with throttled inlet

This is the most common regulation method currently in use. It combines a maximum regulation range (0-100%) with low energy consumption: only 15–30% of full load power with an off-loaded compressor (zero flow). The inlet valve is closed, but with a small opening used at the same time a blow-off valve opens and releases the discharge air from the compressor.

The compressor element therefore works with a vacuum in the inlet and low counterpressure. It is important that pressure relief be carried out

quickly and that the released air volume is limited, in order to avoid unnecessary losses during the transition from loaded to unloaded. The system demands a system buffer volume (air receiver), the size of which is determined by the desired difference between loading and off-loading pressure limits and by the permitted number of unloading cycles per hour.

2:40

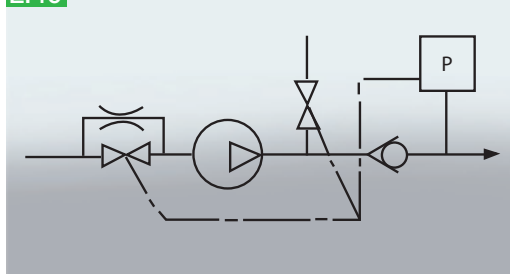

2.5.2.5 Start/stop

Compressors below 5–10 kW are often controlled by completely stopping the electric motor when the pressure reaches an upper limit value and by restarting it when the pressure drops below the lower limit value. This method demands a large system buffer volume or large pressure difference between the upper and lower limits, in order to minimize the heat load on the electric motor. This is an energy-efficient and effective regulation method, provided the number of starts is kept low.

2:41

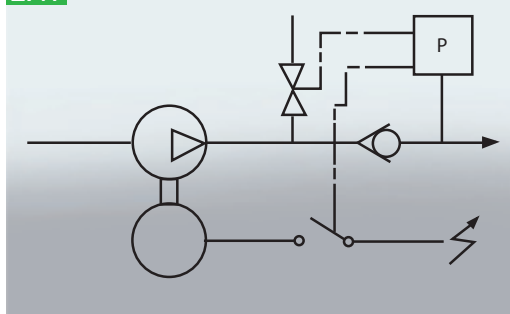

2.5.2.6 Speed regulation

A combustion engine, gas turbine or frequency-controlled electric motor controls the compressor's speed and, consequently, the flow rate. It is an efficient method for maintaining a steady outgoing pressure and lower energy consumption.

The regulation range varies with the type of compressor, and is largest for liquid-injected compressors. Frequently, speed regulation is combined with start-stop at low degrees of loading and pressure relief at standstill.

2:42

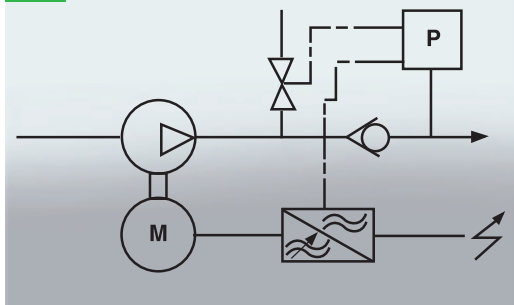

2.5.2.7 Variable discharge port

The flow rate of screw compressors can be regulated by moving the position of the discharge port into the housing, in the rotors' lengthways direction, towards the inlet. However, this method generates high power consumption and is rather unusual.

2.5.2.8 Suction valve unloading

Piston compressors can be effectively regulated by mechanically forcing the inlet valves into the open position. As a result, air is pumped out and into the cylinder with minimal energy loss that is often lower than 10% of the full-load shaft power. Double-acting piston compressors generally provide multi-stage off-loading, whereby one cylinder at a time is off-loaded to better match the flow rate to the demand. An odd method used for process compressors is to allow the inlet valve to be open during a smaller or greater part of the piston stroke to provide nearly continuous flow rate control.

2.5.2.9 Load-unload-stop

This is the most common regulation method used for compressors with greater than 5 kW capacity, and it combines a large regulation range with low losses. It is, in practice, a combination of the start/stop method and different off-loading systems. For additional information, please see 2.5.4.2.

2:43

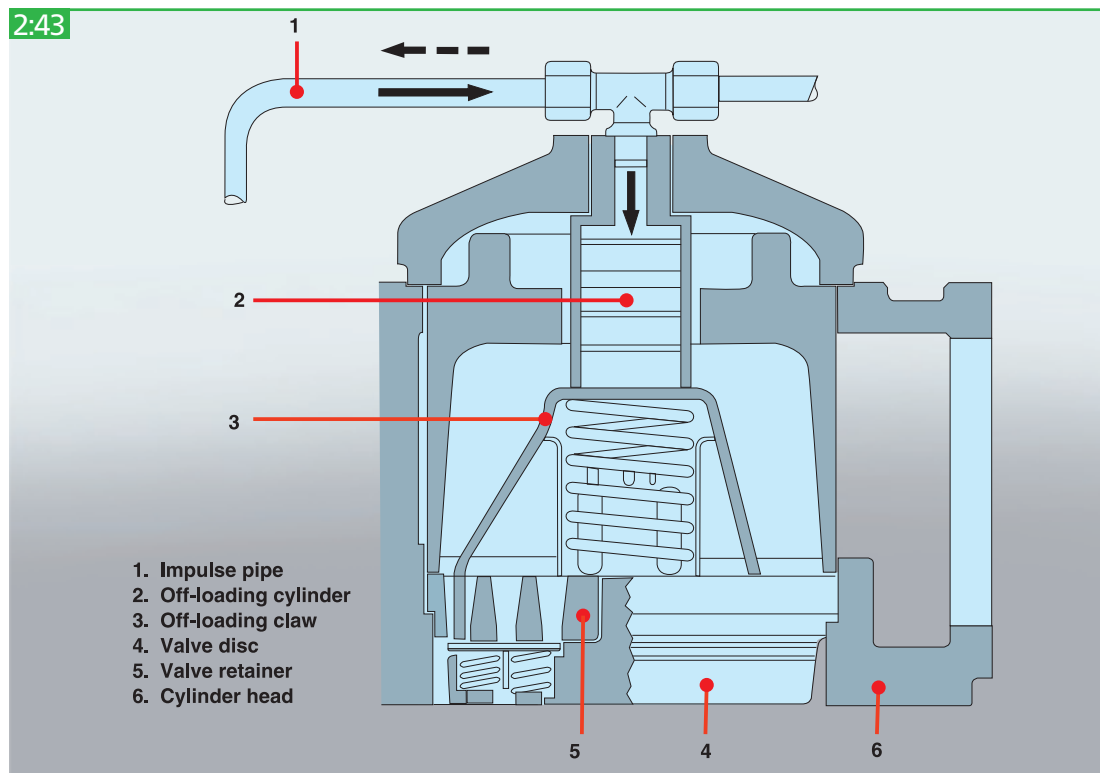

Off-loading device for a piston compressor.

2.5.3 Regulation principles for dynamic compressors

2:44



2.5.3.1 Inlet regulation

Throttling the inlet:

The inlet can be throttled on a dynamic compressor to continuously reduce the capacity of the compressor. The minimum flow is determined when the pressure ratio reaches the pump limit and the machine becomes unstable (surge).

The regulation range is determined by the design of the machine (e.g. the number of stages and the impeller design) but also to a large degree by external factors such as counterpressure, suction temperature, and coolant temperature. The minimum flow often varies between 60% and 85% of the maximum flow.

Inlet guide vanes:

Vanes arranged as radial blades in the intake cause the drawn-in gas to rotate while the flow is throttled. The method has the same impact as throttling, but offers a greater regulation range and features improved energy utilization. Regulation down to 50–70% of the design flow is a typical value. There is also the possibility of increasing slightly the capacity and pressure of the compressor to a certain degree, by turning the vanes in the opposite direction. This, however, may impair performance to a certain degree.

2.5.3.2 Outlet regulation

Variable outlet guide vanes (diffuser):

To further improve the regulation range, the flow in the compressor stage's diffuser may also be controlled. Regulation down to 30% with maintained pressure is common. Usage is limited to single-stage compressors, due to the complexity and increased costs.

Pressure relief:

The original method for regulating dynamic compressors was to use a pressure relief valve or blow-off valve to release excess compressed air into the atmosphere. In principle, this method works identically as with pressure relief on a displacement compressor.

2.5.3.3 Load-unload-stop

Previously mentioned regulation methods can be combined to control the compressor unit. Two modes are commonly used:

- Modulating:
The excess flow is released into the atmosphere (or the inlet), but energy consumption is unchanged.
- Auto dual:
The flow turndown of the unit will be limited to the turndown of the intake valve and/or the outlet guide vanes for flows below the turndown limit. The regulation system fully closes the inlet valve at the same time as the compressor's outlet is opened to the atmosphere (compare with the displacement compressor). The off-loading power is still relatively high, representing 20% of the full load power, depending on the design of the impeller etc.

2.5.3.4 Speed regulation

Speed regulation has a similar effect as the use of inlet guide vanes. Flow can be varied with constant pressure within the compressor turndown range.

At higher powers, speed variation is less advantageous, due to the high cost of the required drive installation.

2.5.4 Control and monitoring

2.5.4.1 General

Regulation principles for different compressors are addressed in sections 2.5.2 and 2.5.3. Controlling compressors according to these principles requires a regulation system that can be used either for an individual compressor or an entire compressor installation.

Regulation systems are becoming more advanced and fast-paced development offers a variety of new solutions. Relay systems have been replaced by programmable equipment (PLC), which, in turn, is currently being replaced by product-adapted systems based on microcomputers. These designs most often aim to optimize operations and costs.

This section presents a few of the control and monitoring systems for the most common types of compressors.

2.5.4.2 Load–unload–stop

The most common regulation principles for displacement compressors are “produce air” / “don’t produce air” (load/unload). (see 2.5.2.4 and 2.5.2.5.)

When air is required, a signal is sent to a solenoid valve that guides the compressor’s inlet valve to the fully open position. The valve is either fully opened (loaded) or fully closed (unloaded); there is no intermediate position.

Traditional control, now common on smaller compressors, uses a pressure switch placed in the compressed air system that has two selectable values: one for the minimum pressure (= loaded) and one for maximum pressure (unloaded). The compressor will then work within the limits of the set values, for example, within a range of 0.5 bar. If the air requirement is very small, the

compressor runs predominantly in off-loaded (idling) mode. The length of the idling period is limited by a timer (set, for example, to 20 minutes). When the set time period elapses, the compressor stops and does not start again until the pressure has dropped to the minimum value. The disadvantage of this method is that it offers slow

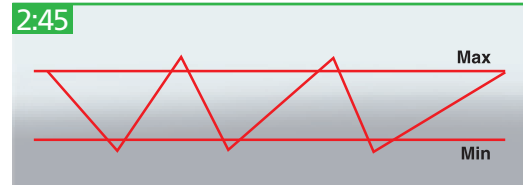

Pressure band, Min–Max, within which the compressor operates: "Min" = load, "Max" = off-load.

regulation.

A further development for this traditional system is to replace the pressure switch with an analogue pressure transducer and a fast electronic regulation system. Together with the regulation system, the analogue transducer can sense how quickly the pressure in the system changes. The system then starts the motor and controls the opening and closing of the damper at the right time. This method offers quick and accurate

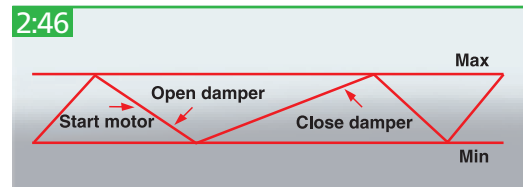

An advanced regulation system can send signals to the motor, starter and regulator at "the right time".

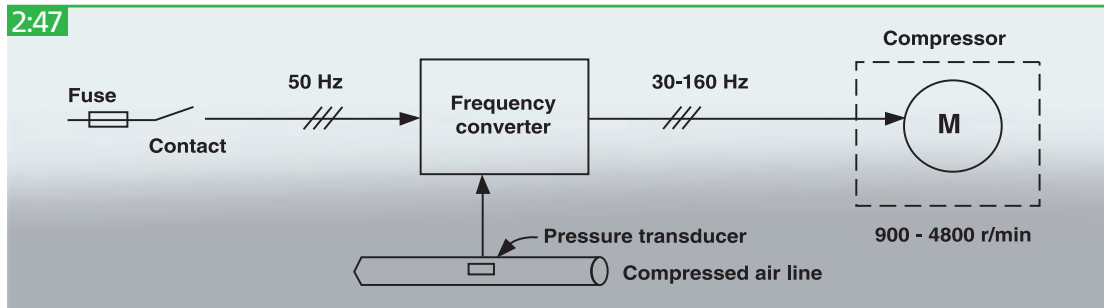

A system with a speed controlled compressor.

regulation within ± 0.2 bar.

If no air is used, the pressure will remain constant and the compressor will run in off-loaded (idling) mode. The length of the idling period is controlled by the maximum number of starts that the electric motor can withstand without running too hot, and by the overall operating cost strategy, as the system can analyze trends in air consumption and thereby decide whether to stop the motor or continue to idle.

2.5.4.3 Speed control

Compressors with a power source whose speed is controlled electronically provide a great opportunity to keep the compressed air constant within a very tight pressure range.

A frequency converter, which regulates the speed on a conventional induction motor, is an example of such a solution. The compressor's capacity can be adapted to the precise air requirement by continuously and accurately measuring the system pressure and then allowing the pressure signals to control the motor's frequency converter and, consequently, the motor's speed. The pressure within the system can be kept within ± 0.1 bar.

2.5.5 Data monitoring

All compressors are equipped with some form of monitoring equipment to protect the compressor and prevent production downtime. The transducer is used to sense the current condition of the installation. Information from the transducers is processed by the monitoring system, which gives a signal to an actuator, for example. A transducer for measuring the pressure or temperature often consists of a sensor and a measurement converter. The sensor senses the quantity to be measured.

The measurement converter converts the sensor's output signal to an appropriate electrical signal that can be processed by the control system.

2.5.5.1 Temperature measurement

A resistance thermometer is normally used to measure the temperature. It features a metal resistor as a transducer whose resistance increases with as temperature increases. The change in resistance is measured and converted to a signal of 4–20 mA. Pt 100 is

2:48

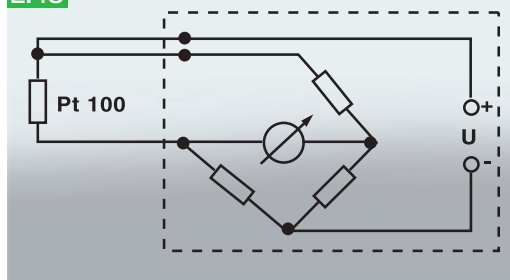

Example of a 3-wire connection using a resistance thermometer of 100 Ω . The resistance thermometer and connectors are connected on a bridge.

the most common resistance thermometer. Nominal resistance at 0°C is 100 Ω .

A thermistor is a semiconductor whose resistance changes with the temperature. It can be used as a temperature controller, for example, on an electric motor. PTC, Positive Temperature Coefficient, is the most common type. The PTC has an insignificant change in resistance with increased temperature up to a reference point, where the resistance increases with a jump. The PTC is connected to a controller, which senses this "resistance jump" and gives a signal to stop the motor, for example.

2.5.5.2 Pressure measurement

A pressure sensing body, for example, a diaphragm, is used to measure pressure. The mechanical signal from the diaphragm is then converted

2:49

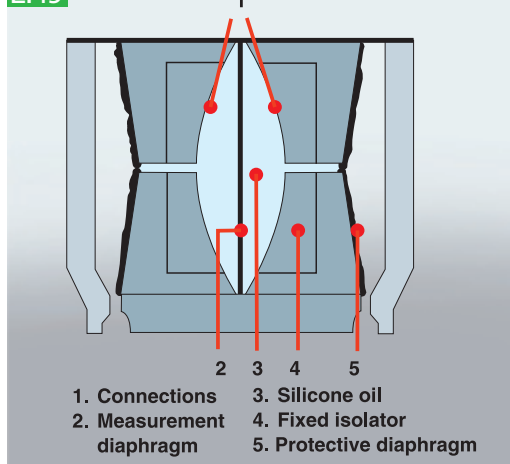

Example of a capacitive system for pressure measurement.

to an electrical signal, 4–20 mA or 0–5 V.

The conversion from a mechanical to an electrical signal can take place in different measurement systems. In a capacitive system, pressure is transferred to a diaphragm. The position of the measurement diaphragm is sensed by a capacitor plate and is converted in a measurement converter to a direct voltage or direct current that is proportional to the pressure.

The resistive measurement system consists of a strain gauge connected in a bridge connection and attached to the diaphragm. When the diaphragm is exposed to pressure, a low voltage (mV) is received. This is then amplified to a suitable level. The piezo-electric system is based on specific crystals (e.g. quartz) that generate electric charges on their surfaces. The charges are proportional to the force (pressure) on the surface.

2:50

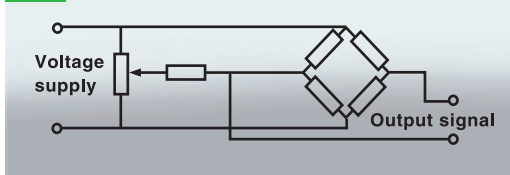

Bridge connection with strain gauges.

2.5.5.3 Monitoring

Monitoring equipment is adapted to the type of compressor. This necessarily involves a large range of equipment to suit all types of compressors. A small piston compressor is only equipped with a conventional overload cut-out for the motor, while a large screw compressor can feature a number of cut-outs/transducers

2:51



A user-friendly monitoring panel displays all the necessary operating parameters.

2:52

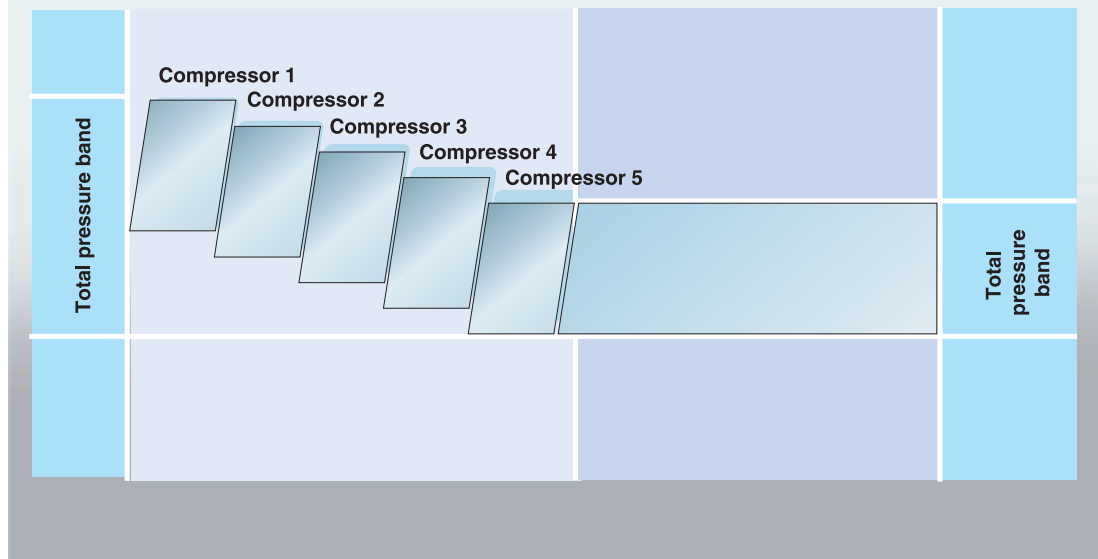

Illustration of the pressure band for five compressors controlled by conventional pressure switches (left-hand field) and the same machines controlled by a regulation system (right-hand field).

for overloading, temperature and pressure, etc. On smaller, more basic machines, the control equipment switches off the compressor and the machine is unable to restart when a cut-out gives an alarm value. A warning lamp can, in some cases, indicate the cause of the alarm.

Compressor operations can be followed on a control panel for more advanced compressors, for example, by directly reading the pressure, temperature and status. If a transducer value approaches an alarm limit, the monitoring equipment will issue a warning. Measures can then be taken before the compressor is switched off. If the compressor is shut down by an alarm, compressor restart is blocked until the fault has been rectified or the compressor is reset manually. Troubleshooting is significantly facilitated on compressors equipped with a memory where data on temperatures, pressure and operating status are logged. The capacity of the memory may cover the last 24 hours. This feature allows trends over the last day to be analyzed and logical troubleshooting to be used to quickly identify the reason for the downtime.

2.5.6 Comprehensive control system

Compressors that are a part of a system composed of several machines should have coordi-

nated compressor operations. There are many factors that make a comprehensive control system advantageous. The division of operating times between machines reduces the risk of unexpected stoppages. Compressor servicing is also easier to plan. Standby machines can be connected if something should occur during operations.

2.5.6.1 Start sequence selector

The simplest and most common form of master control system is the commonly used and tested start sequence selector. This selector equally divides the operating times and starts among the connected compressors. The start sequence can be switched on manually or automatically, following a time schedule. This basic selector uses an on/off pressure transducer, with one transducer per compressor, as a simple and practical solution.

The disadvantage is that there are relatively large steps between the different compressor's loading and off-loading levels. This results in relatively broad pressure bands (the span between maximum and minimum levels) for the installation. This type of selector should therefore not be used to control more than 2–3 compressors. A more advanced type of start sequence selec-

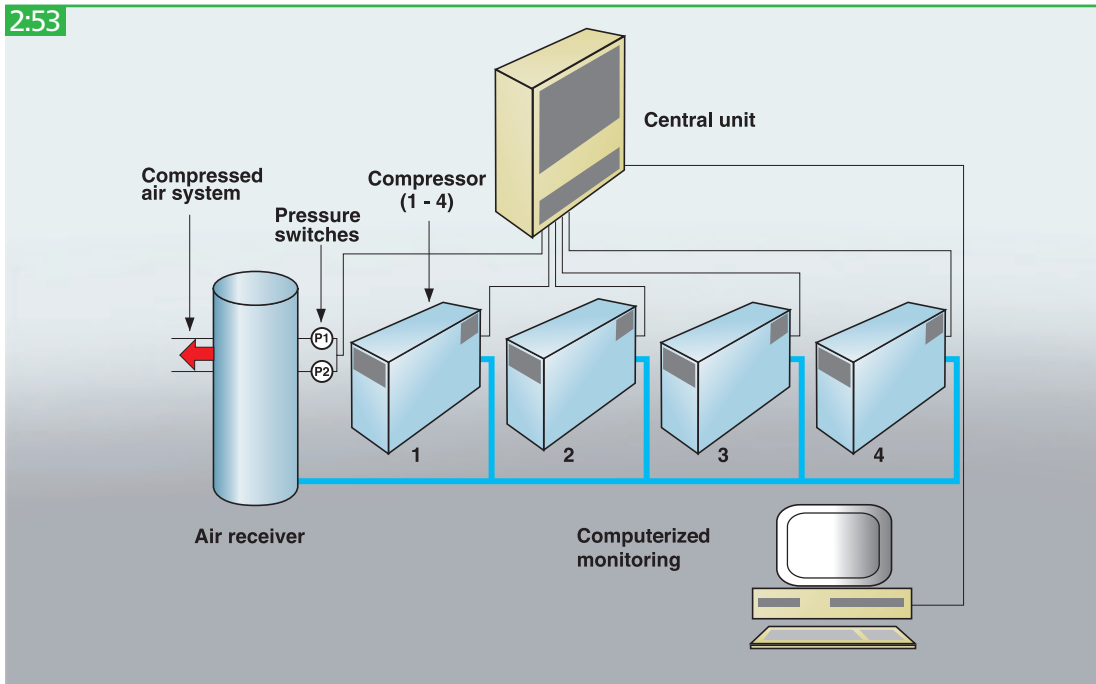

Centrally controlled compressor installation.

tor has the same type of sequence control, but with only one, centrally-positioned, analogue pressure transducer. This manages to keep the installation's total pressure band within a few tenths of a bar and, as a result, can control 2–7 machines. A start sequence selector of this type, which selects the machines in fixed sequences, does not take the capacity of the compressors into account. The connected compressors should thus all be approximately the same size.

2.5.7 Central control

Central control in association with compressors usually signifies relatively intelligent control systems. The basic demand is to be able to maintain a predetermined pressure within tight limits and to provide economic operation for the installation. To achieve this, the system must be capable of predicting what will happen in the system, while at the same time sensing the load on the compressor.

The system senses how quickly the pressure changes in either sense (i.e. the time-derived pressure). Using these values, the system can perform calculations that make it possible to predict the air demand and, for example, to off-load/

load or start/stop the machines. In a correctly dimensioned installation, the pressure fluctuation will be kept within ± 0.2 bar.

It is extremely important for the operational efficiency that the central control system selects the most economical compressor or compressor combination, if compressors of different capacities make up the system. The compressors shall run virtually continuously loaded, thereby minimizing idling periods and providing optimal economy.

Another advantage of a comprehensive control system is that it is generally possible to connect older machines to these systems and therefore modernize the entire compressor installation in a relatively easy manner. Operations become more economic and availability is increased.

2.5.8 Remote monitoring

In various compressor installations, there may be a need to monitor and control compressor operations from a remote location. On smaller installations, it is fairly easy to connect an alarm, operating indicator etc. from the compressor. It is also usually possible to perform remote starting

2:54

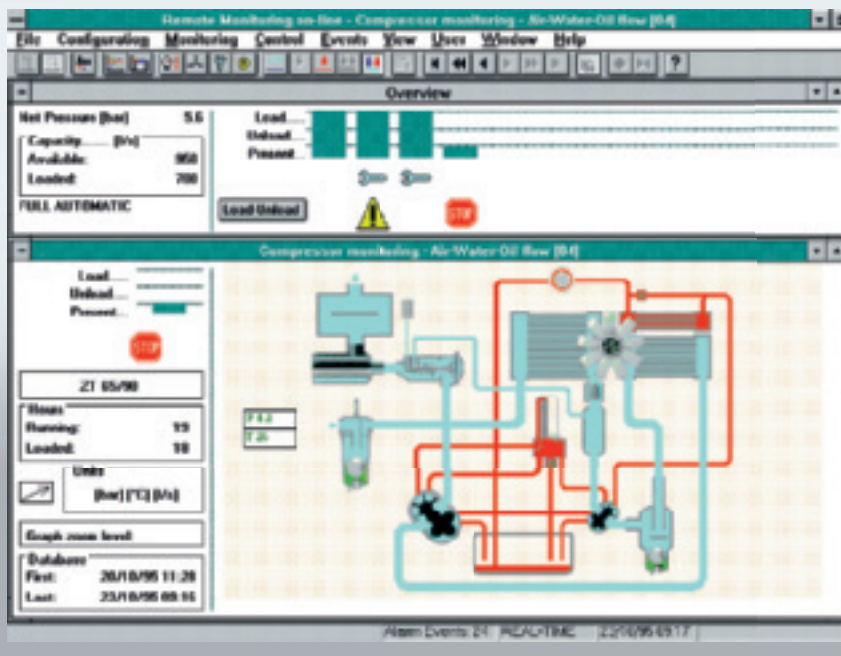

An overview display with remote monitoring. The upper section shows the installation status. Three machines in operation, one stopped. In the lower section details for compressor 4 are shown, among others, flow chart for the compressed air, cooling water and oil as well as prevailing compressor data.

and stopping.

On larger installations, where significant financial investment is at stake, central monitoring is often desirable. It should consist of equipment that provides a continuous overview of the system, and which also provides access to individual machines in order to control details such as the intercooler pressure, oil temperature etc. The monitoring system should also have a mem-

ory in order to produce a log of what has happened over the last 24 hours. The log is used to plot trend curves, which serve to easily identify values that tend to deviate from the default. The curves can form the basis for continuing operations or planning a system stop. The system frequently presents compressor installation status reports at different levels, from a total overview to detailed status for individual machines.

2:55

Pressure range	Pressure bar(e)	Application area
Low	7 - 8.6	Contract work
Medium	10 - 14	Ground stabilization
High	17 - 20	Drilling & industrial
Very high	25 - 35	Water and Geothermal well drilling
Ultra high	35 - 350	Deep hole drilling (oil, gas, mineral, geothermal), well & pipeline services, nitrogen generation

Available pressure ranges and corresponding applications of mobile compressors.

2:56



Modern mobile compressor package for contract work.

2.6 MOBILE COMPRESSORS

2.6.1 General

Nearly all mobile compressors are diesel engine-powered oil-injected screw compressors. Very small as well as very large mobile compressors are sometimes offered with electric motors. Oil-free mobile compressors are produced only by the world's leading manufacturers, for service work in the process industry, utilities and off-shore industry.

Whereas mobile compressors initially were used on construction sites and for off-road drilling, they are now being used in many more applications and processes: road repair, pipeline work, rock reinforcement, sandblasting, salvaging operations, etc. Generally, mobile compressors are packaged as standalone compressed air plants with optional, integrated air treatment equipment on-board (after-cooler, water separator, fine filters, re-heater, lubricator, etc.) as well as optional auxiliary equipment (5 to 10 KVA electric power gener-

ator 230V/400V, cold start aids, anti-theft devices, spillage-free chassis etc). There are mobile, diesel-powered electric power generators built in similar enclosures as mobile compressors for larger power requirements.

2.6.2 Noise level and exhaust emissions

Modern designs of diesel-powered compressors provide very low noise levels as a result of widespread legislation including the EU Directive 2000/14/EC governing noise emissions from machinery used outdoors. These machines can therefore be used without negatively impacting populated areas and areas near hospitals, etc. The silencing enclosure is generally a single-wall steel construction, although double-wall steel and even durable polyethylene enclosures have recently been introduced, containing special baffling and substantial amounts of sound absorbing foam.

Over the passed two decades, fuel economy has improved substantially by introducing very efficient screw compressor elements and efficient packaging. This has been especially valuable for water well drilling, which is a task that requires the compressor to work intensively over a long

period of time. Moreover, modern compressors can be equipped with fuel economy optimizing hardware and software that is far superior to the conventional pneumatic engine/compressor control systems, for example FuelXpert and DrillAirXpert.

Since the introduction of specific exhaust emission legislation in 1997 in the United States, Europe and elsewhere, diesel engines that comply with latest exhaust gas emission requirements are being chosen more often: EURO III will be introduced between 2006-2013, EURO IV from 2014 on, and US Tier 4 between 2008 and 2015.

2.6.3 Operational flexibility

Whereas stationary industrial compressors are installed to serve only one or a few applications along a common compressed air distribution system, modern mobile compressors must demonstrate high overall operational flexibility to serve a multitude of applications in different environments based on ambient temperatures, humidity levels, working pressures, altitudes and load cycle profiles. Other requirements relative to mobile compressors include high operating reliability, good service characteristics, small environmental impact resulting from low noise levels and regulated exhaust emission levels, compact dimensions and a low total weight.

Operation in climates with medium to high humidity, in particular when the load/unload profile contains load cycles at high pressure or long periods of unload operation, will cause some of the atmosphere water content to condense inside the compressor oil circuit. This has a negative impact on the lubricated compressor components as well as on the oil itself. Having just 1% of water in the oil will reduce the useful life of the bearings by 40%. The most modern mobile compressors can be equipped with an electronic oil temperature control system to protect the compressor's operating life.

3 DIMENSIONING AND SERVICING COMPRESSOR INSTALLATIONS

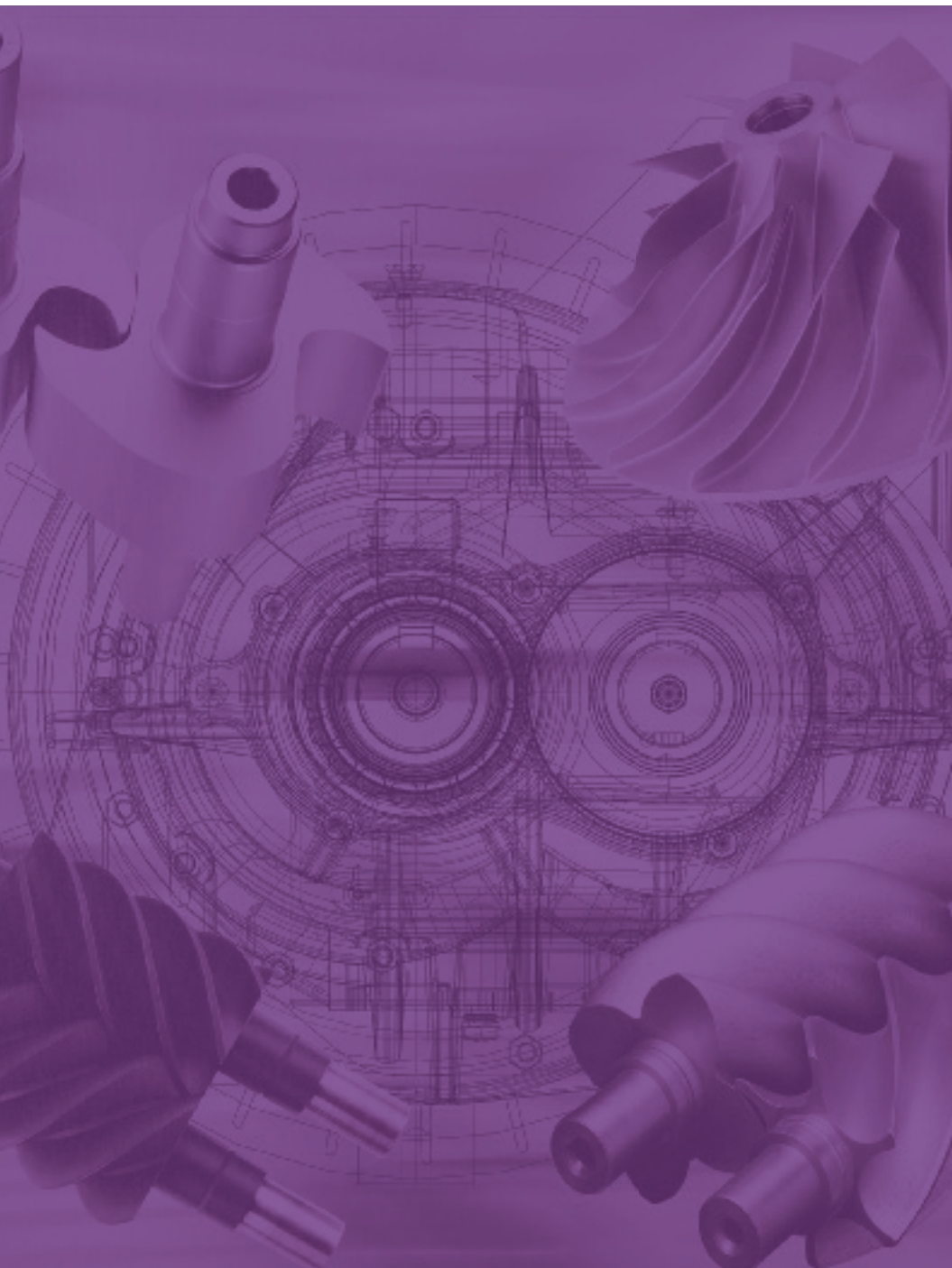

3.1 DIMENSIONING COMPRESSOR INSTALLATIONS

3.1.1 General

A number of decisions must be made when dimensioning a compressed air installation for it to suit the user's needs, provide maximum operating economy and be prepared for future expansion.

The foundation is the applications or process that will use the compressed air. Therefore, these must be mapped out as a starting point for all other dimensioning activities.

The areas that must be examined include the calculation or assessment of the air requirement and the reserve capacity and the space for future expansion. The working pressure is a critical factor, as this significantly impacts energy consumption. Sometimes it can be economical to use different compressors for different pressure ranges. The quality of the compressed air is not only a question of water content, but has increasingly become an environmental issue as well. Odor and the microorganism content are important factors that can affect the product quality, rejections, the working environment and the outdoor environment. The issue of whether the compressor installation should be centralized or decentralized may affect the floor space requirement and perhaps future expansion plans. From both a financial and ecological point of view it is becoming increasingly important to investigate

the possibilities of recovering energy at an early stage for quick return on investment.

It is important to analyze these types of issues with regard to current as well as future requirements. Only after doing so will it be possible to design an installation that offers sufficient flexibility.

3.1.1.1 Calculating the working pressure

The compressed air equipment in an installation determines the requisite working pressure. The correct working pressure does not just depend on the compressor, but also on the design of the compressed air system and its piping, valves, compressed air dryers, filters, etc.

Different types of equipment can demand different pressures within the same system. Normally, the highest pressure determines the requisite installation pressure and other equipment will be fitted with pressure reducing valves at the point of consumption. In more extreme cases, the method can be uneconomical and a separate compressor for special needs can be a solution. It should also be kept in mind that the pressure drop quickly increases as flow increases. If a change in consumption can be expected, it makes economic sense to adapt the installation to these conditions.

Filters and special dust filters, have a low initial pressure drop, but become clogged over time and are replaced at the recommended pressure drop. This factor will enter into the calculation. The compressor's flow regulation also causes pressure variations and therefore must also be included in the assessment. It may be appropriate to perform calculations using the following example:

3:1

Connected equipment	Nominal air requirement	Utilisation factor max/min	Total air requirement max/min
Tools, total			
Production lines, total			
Process lines, total			

The air requirement for connected equipment is obtained from tool catalogues and production equipment data. By assessing the individual utilization factors one can determine upper and lower limits for the overall air demand.

Description	Pressure drop bar
End user	6
Final filter	0.1–0.5
Pipe system	0.2
Dust filter	0.1–0.5
Dryer	0.1
Compressor regulation range	0.5
Compressor max. working pressure	7.0–7.8

It is the primarily the end consumer application along with the pressure drop between the compressor and the consumer that determines the pressure the compressor will need to produce. The working pressure can be determined by adding the pressure drop to the system, as shown in the example above.

3.1.1.2 Calculating the air requirement

The nominal compressed air requirement is determined by the individual air consumers. This is calculated as a sum of air consumption for all tools, machines and processes that will be connected, and estimating their individual utilization factor by experience. Additions for leakage, wear and future changes in the air requirement must also be taken into consideration from the outset.

A simple method to estimate the present and future air requirement is to compile the air requirement for connected equipment and

the utilization factor. This type of calculation requires a list of machines and their respective air consumption data and expected utilization factors. If data is not available for the air consumption or utilization factor, standard values from lists may be used. The utilization factor for tools can be difficult to estimate, therefore calculation values should be compared with measured consumption in similar applications.

For example, large air-powered consumers such as grinders and sandblasting machines are used frequently for long periods (3–10 minutes) at continuous operation, despite their low overall utilization factor. This cannot truly be characterized as intermittent operation, and it is necessary to estimate how many machines will be used simultaneously in order to estimate total air consumption.

Compressor capacity is essentially determined by the total nominal compressed air requirement. The compressors' free output flow rate should cover this rate of air consumption. The calculated reserve capacity is primarily determined by the cost of lost production resulting from a potential compressed air failure.

The number of compressors and their mutual size is determined principally by the required degree of flexibility, control system and energy efficiency. In an installation in which only one compressor supplies compressed air (due to cost restrictions), the system can be prepared for quick connection of a portable compressor as part of servicing. An older compressor used as a reserve source, can be used as inexpensive reserve power.

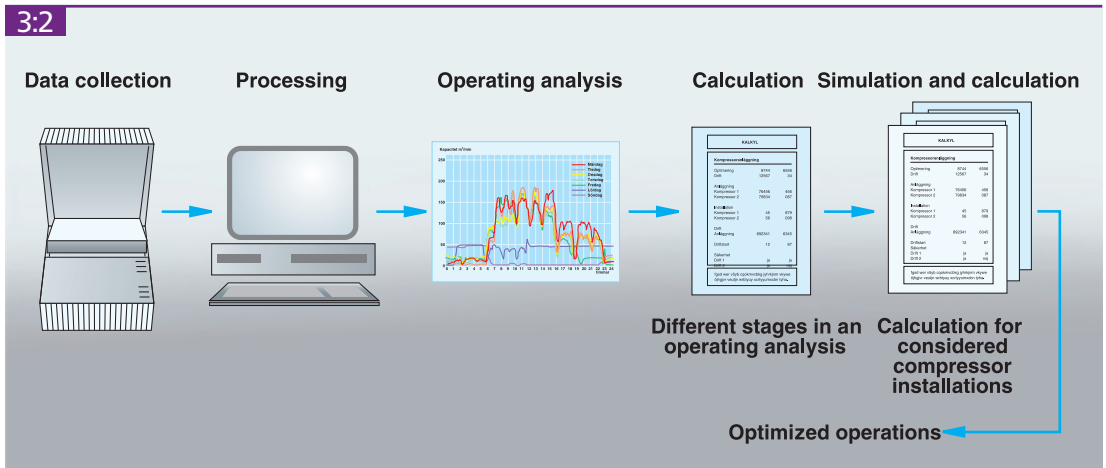

Method of operation analysis.

3:3

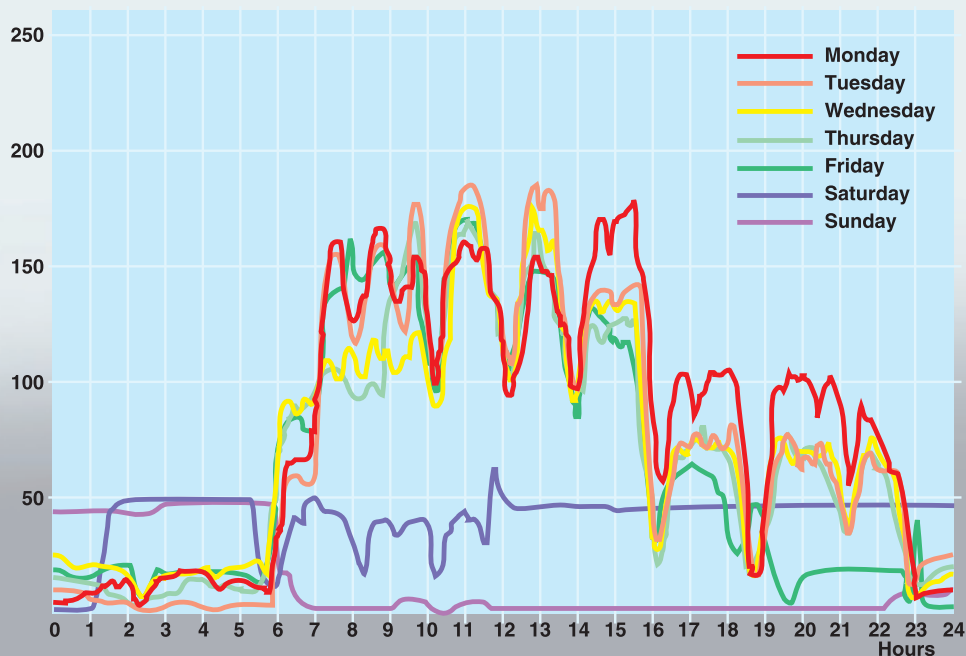
Capacity m³/min

During an operation analysis the compressed air production is continuously measured for a full week.

3.1.1.3 Measuring the air requirement

An operating analysis provides key factors about the compressed air requirement and forms the basis for assessing the optimal amount of compressed air to produce. Most industrial companies are constantly evolving, and this means that their compressed air requirements also change. It is therefore important that the compressed air supply be based on the current prevailing conditions, and an appropriate margin for expansion be built into the installation.

An operating analysis entails measuring operating data, which is possibly supplemented with the inspection of an existing compressed air installation over a suitable period of time. This analysis should cover at least one week of operations and the measurement period should be selected with care to allow it to represent a typical case and provide relevant data. The stored data also provides an opportunity to simulate different measures and changes in compressor operations and to analyze the impact on the installation's overall economy.

Factors such as loading times and off-loading times also enter into the total assessment of compressor operations. These provide the basis for assessing the loading factor and the compressed air requirement, spread over a day or a work week. Accordingly, the loading factor cannot just be read off of the compressor's running hour meter.

An operating analysis also gives a basis for potential energy recovery. Frequently, more than 90% of the energy supplied can be recovered. Furthermore, the analysis can provide answers relating to dimensioning as well as the operating method for installation. For example, the working pressure can often be reduced at certain times and the control system can be modified in order to improve compressor usage with changes in production. It is also fundamentally important to check for leakage.

For the production of small quantities of air during the night and weekends, you must consider whether it is worth installing a smaller compressor to cover this requirement.

3:4

Hole diameter: mm	1	3	5	10
Leakage, (l/s) at 6 bar	1	10	27	105
Power loss, kW at the compressor	0,3	3,1	8,3	33

Even small leakages can result in large costs and downtime.

3.1.2 Centralization or decentralization

3.1.2.1 General

There are several factors that influence the choice between one large centralized or several smaller decentralized compressors to meet a given compressed air requirement. Factors that are taken into consideration include the cost of a production shutdown, guaranteed availability of electrical power, loading variations, costs for the compressed air system and the available floor space.

3.1.2.2 Centralized compressor installations

A centralized compressor installation is in many cases the solution of choice, as it is less expensive to run and maintain than several, locally distributed compressors. Compressor plants can be efficiently interconnected, thereby resulting in lower energy consumption. A central installation also involves lower monitoring and maintenance costs as well as better opportunities for recovering energy. The overall floor area required for the compressor installation is also minimized. Filters, coolers and other auxiliary equipment and the common air intake can be optimally dimensioned. Noise reduction measures will also be easier to fit.

A system comprising several, different sized compressors in a central installation can be sequence controlled to improve efficiency. One large compressor may have more difficulty meeting large

variations in the compressed air requirement without losing efficiency.

For example, systems with one large compressor are often supplemented with a smaller compressor for use during periods such as a night shift or on weekends. Another factor worth considering is the impact that starting a large electric motor has on the mains supply.

3.1.2.3 Decentralized compressor installations

A system with several decentralized compressors can also be the preferred choice for certain applications. It involves a smaller, simpler compressed air distribution system. A disadvantage of decentralized compressors lies in the difficulty of inter-regulating the compressed air supply and in maintaining a reserve capacity. Modern compressors with fully-integrated compressed air conditioning equipment (dryers, filters etc.) and with high-performance silencing measures can be installed at the worksite, thus reducing compressed air distribution costs and eliminating the need for a separate building or an extension to the separate compressor room.

Decentralized compressors can be utilized to maintain the pressure in a system with a large pressure drop if the intermediate processes temporarily draw too much air. An alternative with extremely short peaks of air consumption is to solve the problem by positioning buffers (air receiver) in strategic locations.

A unit or building normally supplied from a compressed air plant and which is the sole consumer of compressed air during specific periods can be sectioned off and supplied with its own decentralized compressor. The advantage of this layout is that it avoids "feeding" any leakage in the remaining part of the system and that the localized compressor may be adapted to the smaller requirement.

3.1.3 Dimensioning at high altitude

3.1.3.1 General

Both the ambient pressure and temperature decrease with altitude above sea level. This lower inlet pressure impacts the pressure ratio, for the compressors as well as for the connected equipment, which, in practice, signifies an impact on both power consumption and air consumption. At the same time, the changes due to higher

3:5

Atmospheric pressure

Height below/above sea level	Pressure bar(a)	Temperature °C
-1000	1.138	21.5
-800	1.109	20.2
-600	1.080	18.9
-400	1.062	17.6
-200	1.038	16.3
0	1.013	15.0
200	0.989	13.7
400	0.966	12.4
600	0.943	11.1
800	0.921	9.8
1000	0.899	8.5
1200	0.877	7.2
1400	0.856	5.9
1600	0.835	4.6
1800	0.815	3.3
2000	0.795	2.0
2200	0.775	0.7
2400	0.756	-0.6
2600	0.737	-1.9
2800	0.719	-3.2
3000	0.701	-4.5
3200	0.683	-5.8
3400	0.666	-7.1
3600	0.649	-8.4
3800	0.633	-9.7
4000	0.616	-11.0
5000	0.540	-17.5
6000	0.472	-24.0
7000	0.411	-30.5
8000	0.356	-37.0

The table shows the standardized pressure and temperature at different altitudes. The pressure is also dependent on the weather and varies approx. $\pm 5\%$, while the local season dependent temperature variations can be considerable.

altitude will also affect the available rated power from electric motors and from combustion engines.

The way in which ambient conditions influence the end consumer application must also be taken into account. Is a specific mass flow rate (in a process) or a volume flow rate required? Was the pressure ratio, absolute pressure or gauge pressure used for dimensioning? Is the compressed air temperature significant?

All of these considerations create different conditions for dimensioning a compressed air installation installed at a high altitude and can be fairly complex to calculate. If anything is unclear or for any questions, the installer should always contact the equipment manufacturer.

3.1.3.2 The effect on a compressor

To choose the correct compressor where the ambient conditions differ from those stated on the data sheet, the following factors should be taken into consideration:

- Height above sea level or ambient pressure
- Ambient temperature
- Humidity
- Coolant temperature
- Type of compressor
- Power source

These factors primarily affect the following:

- Max. working pressure
- Capacity
- Power consumption
- Cooling requirement

3:6

Compressor type	Reduction per 1000m altitude increase	
	Free Air Delivery FAD%	Mass air flow% Normal air flow%
Single stage oil-free screw compressor	0.3	11
Two stage oil-free screw compressor	0.2	11
Single stage oil injected screw compressor	0.5	12
Single stage piston compressor	5	17
Two stage piston compressor	2	13
Multi-stage centrifugal compressor	0.4	12

Altitude effect on the compressor at 7 bar(e) working pressure and constant ambient temperature. Bear in mind that each compressor type has a maximum pressure ratio that can not be exceeded.

3:7

Height above sea level, metres	Ambient temperature, °C					
	<30	30-40	45	50	55	60
1000	107	100	96	92	87	82
1500	104	97	93	89	84	79
2000	100	94	90	86	82	77
2500	96	90	86	83	78	74
3000	92	86	82	79	75	70
3500	88	82	79	75	71	67
4000	82	77	74	71	67	63

Permitted load in % of the electric motor's rated power.

The most important factor is the inlet pressure variations at altitude. A compressor with a pressure ratio of 8.0 at sea level will have a pressure ratio of 11.1 at an altitude of 3000 meters (provided that the application's operating pressure is unchanged). This affects the efficiency and, consequently, the power requirement. The amount of change is dependent on the type of compressor and the design, as detailed in Figure 3:6.

The ambient temperature, humidity and coolant temperature all interact and affect the compressor performance to different degrees on single-stage or multi-stage compressors, dynamic compressors or displacement compressors.

3.1.3.3 Power source

3.1.3.3.1 Dimensioning electric motors

Cooling is impaired on electric motors by the lower density air at high altitudes. Standard motors should be able to work up to 1000 m and with an ambient temperature of 40°C without any impacts on rated data. At higher altitudes, Table 3:7 can be used as a guide for standard motor performance deration. Note that for some compressor types, the electric motor performance is impaired more than the compressor requisite shaft power at high altitude. Therefore,

operating a standard compressor at high altitude requires lowering the working pressure or else fitting an oversized motor.

3.1.3.3.2 Dimensioning IC engines

A reduction in ambient pressure, temperature increase or reduction in humidity reduces the oxygen content in the air used for combustion and, consequently, the extractable power from the internal combustion (IC) engine. The degree of shaft power de-ration depends on the type of engine and its breathing method (naturally aspirated or turbocharged) as set out in Figure 3:8. The humidity plays a smaller role (de-ration <1% per 1000 m) when the temperature falls below 30°C.

Note that the engine power falls more rapidly than the compressor requisite shaft power. This implies that for each compressor/engine combination, there is a maximum working height that will use the entire power margin of the engine over the compressor for use at sea level. Generally, suppliers should be entrusted with calculating and stating the specific data that applies to the compressor, engine and air consumption equipment in question.

3:8

Engine type	Power reduction in % per 1000 m	Power reduction in % per 10°C temperature increase
Naturally aspirated engine	12	3.6
Turbocharged engine	8	5.4

Available combustion engine power in function of altitude and temperature.

3.2 AIR TREATMENT

3.2.1 General

It is vitally important to the user that the compressed air be of the right quality. If air that contains contamination comes into contact with the final product, rejection costs can quickly become unacceptably high and the cheapest solution can quickly become the most expensive. It is important that you select the compressed air quality in line with the company's quality policy and even attempt to judge future requirements.

Compressed air can contain unwanted substances, for example, water in drop or vapor form, oil in drop or aerosol form, as well as dust. Depending on the compressed air's application area, these substances can impair production results and even increase costs. The purpose of air treatment is to produce the compressed air quality specified by the consumer.

When the role of compressed air in a process is clearly defined, finding the system that will be

the most profitable and efficient in that specific situation is simple. It is a question, among others, of establishing whether the compressed air will come into direct contact with the product or whether, for example, oil mist can be accepted in the working environment. A systematic method is required to select the right equipment.

3.2.2 Water vapor in compressed air

Air in the atmosphere always contains moisture in the form of water vapor. Some water vapor is included in the compressed air and can potentially cause problems. Examples include: high maintenance costs, shortened service life and impaired tool performance, high rate of rejection with spray painting and plastic injection, increased leakage, disturbances in the control system and instruments, shorter service life for the pipe system due to corrosion and more expensive installation. The water can be separated using accessories: after-coolers, condensation separators, refrigerant dryers and adsorption dryers.

3:9

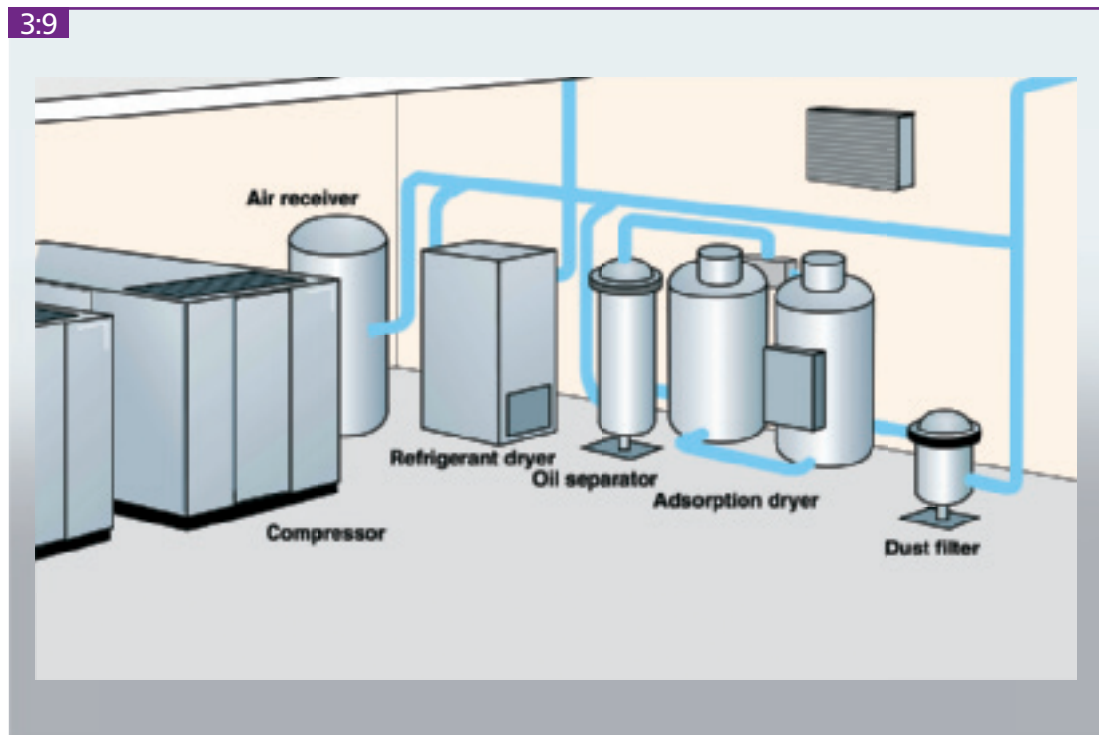

The main components in a typical compressed air system installation. The air treatment equipment determines the quality of the compressed air, which may have an effect on the economy of the installation.

3:10

Class	Maximum number of particles per m ³			Water	Oil
	for particle sizes, d(≤ μm)			Max. pressure	Max. conc.
	0,1 < d ≤ 0,5	0,5 < d ≤ 1,0	1,0 < d ≤ 5,0	dew point (°C)	(mg/m ³)
0	As specified by the equipment user or supplier and more stringent than class 1				
1	≤20000	≤400	≤10	-70	0.01
2	≤400000	≤6000	≤100	-40	0.1
3	not specified	≤90000	≤1000	-20	1
4	not specified	not specified	≤10000	+3	5
5	not specified	not specified	≤100000	+7	>5
6	0 < c _p ≤ 5			+10	-

c_p = Mass concentration in mg/m³
 Oil = Total oil concentration (liquid, aerosol and vapor)

Table is taken from ISO 8573-1 (2010).

A compressor that works with 7 bar(e) overpressure compresses air to 7/8 of its volume. This also reduces the air's ability to hold water vapor by 7/8. The quantity of water that is released is considerable. For example, a 100 kW compressor that draws in air at 20°C and 60% relative humidity will give off approximately 85 liters of water during an 8 hour shift. Consequently, the amount of water that will be separated depends on the compressed air's application area. This, in turn, determines which combination of coolers and dryers are suitable.

3.2.3 Oil in compressed air

The quantity of oil in compressed air depends on several factors, including the type of machine,

design, age and condition. There are two main types of compressor design in this respect: those that function with lubricant in the compression chamber and those that function without lubricant. In lubricated compressors, oil is involved in the compression process and also is included in the (fully or partially) compressed air. However, in modern, lubricated piston and screw compressors the quantity of oil is very limited. For example, in an oil-injected, screw compressor, the oil content in the air is less than 3 mg/m³ at 20°C. The oil content can be reduced further by using multi-stage filters. If this solution is chosen, it is important to consider the quality limitations, risks and energy costs involved.

3:11

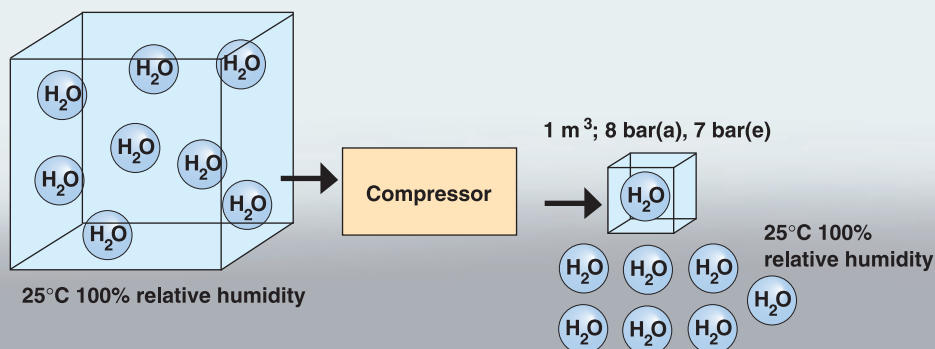

A compressor that works at 7 bar(e) gauge pressure, compresses air to 1/8 of its volume.

3.2.4 Micro-organisms in compressed air

More than 80% of the particles that contaminate compressed air are smaller than $2\ \mu\text{m}$ in size and can therefore easily pass through the compressor's inlet filter. From that point, the particles spread throughout the pipe system and mix with the water and oil residue and pipe deposits. This can result in the growth of micro-organisms. A filter positioned directly after the compressor can eliminate these risks. Nevertheless, to have pure compressed air quality, bacteria growth after the filter must be kept fully under control.

The situation is complicated further as gases and aerosol can be concentrated into droplets (through concentration or electrical charging) even after passing several filters. Micro-organisms can germinate through the filter walls and therefore exist in the same concentrations on the inlet as well as the outlet sides of the filter.

Micro-organisms are extremely small and include bacteria, viruses and bacteriophages. Typically, bacteria can be as small as $0.2\ \mu\text{m}$ to $4\ \mu\text{m}$ and viruses from $0.3\ \mu\text{m}$ to as small as $0.04\ \mu\text{m}$. Contamination smaller than $1\ \mu\text{m}$ diameter and, consequently, micro-organisms can pass easily

through the compressor inlet filter. Despite their size, these micro-organisms are a serious problem in many industries, because as 'living' organisms they are able to multiply freely under the right conditions. Investigations have established that micro-organisms thrive in compressed air systems with non-dried air at high humidity (100%). Oil and other contamination act as nutrients and allow micro-organisms to flourish. The most effective treatment involves drying air to a relative humidity of $<40\%$ (this can be achieved by using any type of dryer) and fitting a sterile filter in the system. The sterile filter must be fitted in a filter housing that allows in situ steam sterilization or that can be easily opened. Sterilization must be performed frequently to maintain good air quality.

3.2.5 Filters

Modern fiber filters are very efficient at removing oil. However, it is difficult to precisely control the quantity of oil remaining in the air after filtration as temperature, among other factors, has an significant impact on the separation process. Filter efficiency is also impacted by the oil concentration in the compressed air as well as the

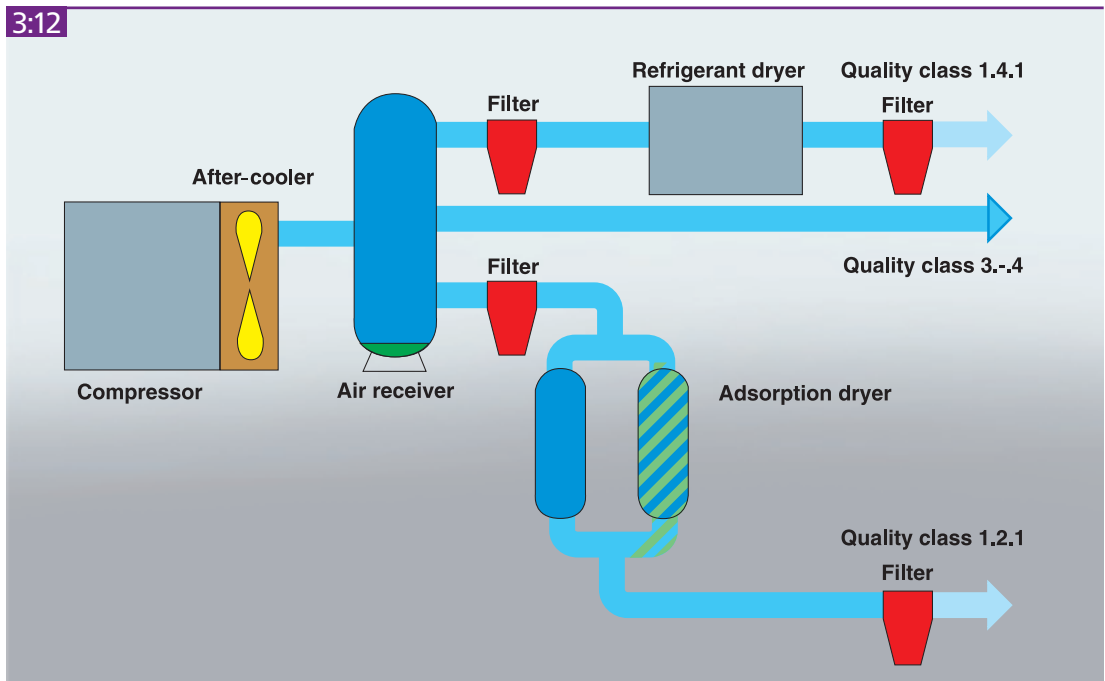

Schematic of an installation that can deliver compressed air at different air quality classes in accordance with ISO 8573-1.

amount of free water. Data stated in the filter specification always applies to a specific air temperature, usually 21°C. This corresponds to the approximate air temperature after an air-cooled compressor working in an ambient temperature of 10°C. However, climate and seasonal changes may cause temperature variations, which will, in turn, affect the filter's separation capacity.

The air should be as dry as possible to achieve the best results. Oil, activated carbon and sterile filters all provide poor results if free water is present in the air (the filter specifications do not apply under such conditions). Fiber filters can only remove oil in the form of droplets or as aerosols. Oil vapor must be removed using a filter with activated carbon. A correctly installed fiber filter, together with a suitable pre-filter, can reduce the quantity of oil in the compressed air to approximately 0.01 mg/m³. A filter with activated carbon can reduce the quantity of oil to 0.003 mg/m³.

Activated carbon is produced specifically to cover an extensive internal surface. Activated carbon is able to absorb 10-20% of its own weight in oil.

A filter coated with activated carbon powder therefore contains only a small amount of carbon powder. This limits its lifetime, and its use is restricted to 20°C. The bulk activated carbon bead filter contains a large amount of activated carbon. This makes it more suitable for many applications (even at higher temperatures) and increases the lifetime of the filter.

This lifetime is influenced by the temperature of the air. As the temperature increases, the amount of oil vapor increases exponentially. Activated carbon filters should contain the appropriate quantity of carbon and should be dimensioned to create the lowest possible pressure drop. Filters with activated carbon only remove air contamination in the form of vapor and should be preceded by other, appropriate filters. For optimal effect, the filters should also be placed as close as possible to the application in question. Additionally, they must be checked regularly and replaced frequently.

An oil-free compressor eliminates the need for an oil filter. This means the compressor can work at a lower discharge pressure, thereby reducing energy consumption. It has been shown in many cases that oil-free compressors are the best solu-

tion, both from an economical standpoint and for the quality of air.

3.2.6 After-cooler

The compressed air from the compressor is hot after compression, often at a temperature between 70–200°C. An after-cooler is used to lower this temperature, which in turn also reduces the water content. Today, this equipment is frequently included as standard equipment for a compressor installation. The after-cooler should always be placed directly after the compressor. The heat exchanger cools the hot air and then routes most of the condensation water, which would otherwise flow into the system, as quickly as possible. The after-cooler can be either water- or air-cooled and is generally fitted with a water separator featuring automatic drainage.

3.2.7 Water separator

Most compressor installations are fitted with an after-cooler as well as a water separator, in order to separate as much condensation water as possible from the compressed air. With the right choice and sizing of the water separator, an efficiency of 80-90% can be achieved. The remaining water flows with the compressed air as water mist into the air receiver.

3.2.8 Oil / water separation

Oil in the form of droplets is separated partly in an after-cooler, condensation separator or a condensation tap and flows through the system with the condensation water. This oil/water emulsion is classed from an environmental point of view as waste oil and must not be drained off into the sewage system or directly into nature.

New and more stringent laws are continuously being introduced with regard to the handling of environmentally hazardous waste. The condensation drainage, as well as its collection, is complex and expensive.

An easy and cost-effective solution to this problem involves installing an oil/water separator, for example, with a diaphragm filter to produce clean drainage water and to drain the oil off into a special receiver.

3:13

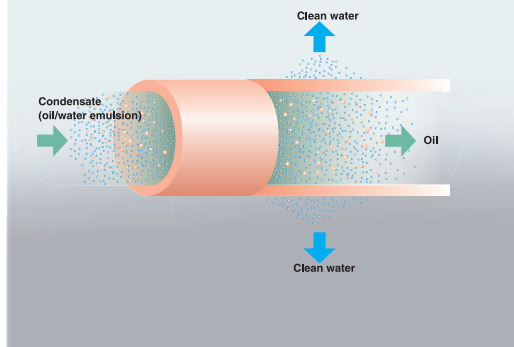

Operating principle of a diaphragm filter for oil separation. The diaphragm lets through small molecules (clean water), while larger molecules (oils) are kept in the system and can be collected in a container.

3.2.9 Medical air

In addition to regular air purity requirements, there are special applications that require an even higher degree of air treatment purification. High quality air is of vital importance to many industries, but nowhere is this so literally true as in the medical sector. The purity of medical air for hospital patients must be 100% guaranteed.

However, the air drawn from our environment to produce medical air, especially in cities or industrial areas, is rarely of a sufficient quality to begin with.

Medical air filtration consists of several purifying stages to treat compressed air so that the result is extremely clean. By using a water separator and two coalescing filters, contaminants like water, particles and oil droplets are eliminated from the air before it goes into the cold regenerative adsorption dryer. This dryer lowers the dew point to -40°C , which is the temperature required to qualify for medical use.

After going through the adsorption dryer, the air passes through an extra filtration stage, whose function is twofold. Activated carbon (also see Section 3.2.5 on activated carbon) reduces hydrocarbons such as oil vapor and smells to harmless levels, and a catalyst converts excessive concentrations of carbon oxide into carbon dioxide. In this filtration stage, sulfur oxide and nitrogen oxide contaminants are also reduced to an absolute minimum. In the final stage, a particle filter eliminates dust particles that may have been introduced into the air by the dryer or the extra filtration unit. The requirements for the medical market differ for each country, and are governed by local legislation.

3:14

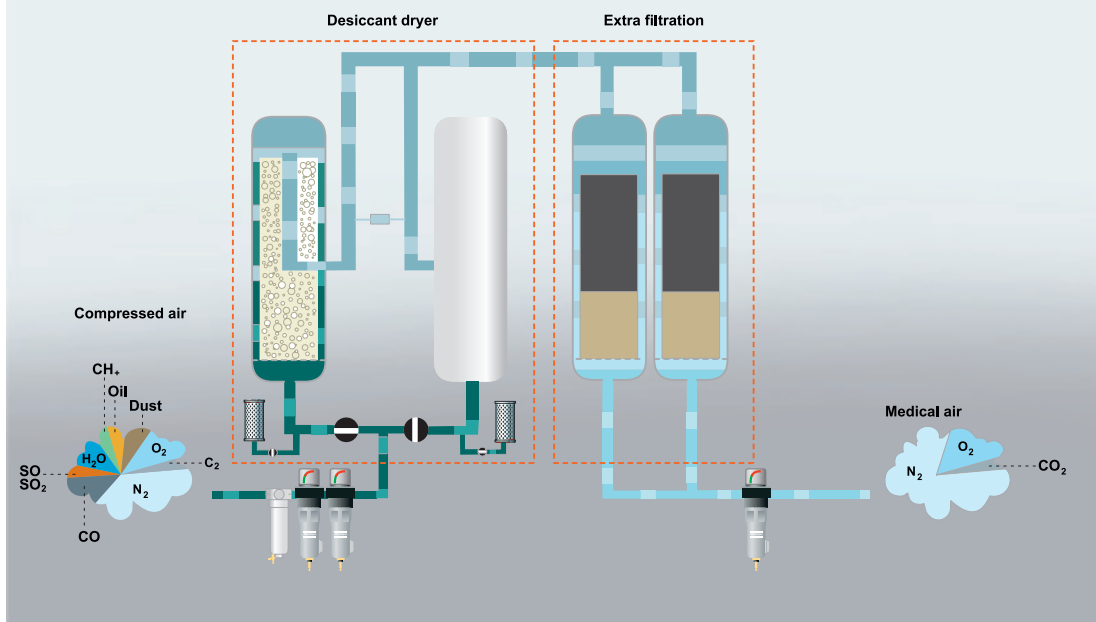

Schematic of an installation that delivers medical air.

3.3 COOLING SYSTEM

3.3.1 Water-cooled compressors

3.3.1.1 General

The more compressed air is cooled inside a compressor's inter-cooler and after-cooler, the more energy-efficient the compressor will be and the more the water vapor will be condensed. A water-cooled compressor installation puts little demand on the compressor room ventilation system, as the cooling water contains, in the form of heat, approximately 90% of the energy taken up by the electric motor.

Compressor water cooling systems can be based on one of three main principles: open systems without circulating water (connected to an external water supply), open systems with circulating water (cooling tower), and closed systems with circulating water (including an external heat exchanger/radiator).

3.3.1.2 Open system without circulating water

In an open system without circulating water, water is supplied by an external source: municipal water mains, lake, stream, or well and after

passing through the compressor, this water is discharged as wastewater. The system should be controlled by a thermostat, to maintain the desired air temperature as well as to govern water consumption.

Generally, an open system is easy and inexpensive to install, but expensive to run, especially if the cooling water is taken from the municipal water mains. Water from a lake or stream is normally free of charge, but must be filtered and purified to limit the risk of clogging the cooling system. Furthermore, water that is rich in lime can result in boiler scale forming inside the coolers, and causing gradually impaired cooling. The same applies to salt water, which may however be used if the system is designed properly and dimensioned accordingly.

3.3.1.3 Open system with circulating water

In an open system with circulating water, cooling water from the compressor is re-cooled in an open cooling tower. Water is cooled in the cooling tower by allowing it to sprinkle down into a chamber as surrounding air is blown through. As a result, part of the water evaporates and the remaining water is cooled to 2°C below the ambient temperature (this may vary depending on the temperature and relative humidity).

3:15

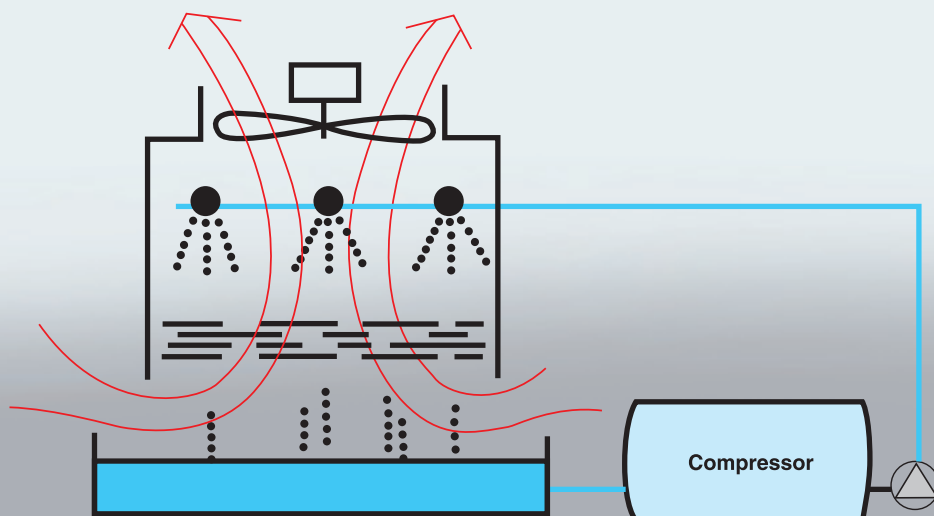

Open cooling system with circulating cooling water.

Open systems with circulating water are primarily used when the availability of an external water supply is limited. The disadvantage to this system is that the water gradually becomes contaminated by the surrounding air. The system must be continuously diluted using external water due to evaporation. Dissolvable salts are deposited on the hot metal surfaces, reducing the thermal heat transfer capacity of the cooling tower. The water must be regularly analyzed and treated with chemicals to avoid algae growth in the water. During winter, when the compressor is not operating, the cooling tower must either be drained or the water must be heated to prevent freezing.

3.3.1.4 Closed system

In a closed cooling system, the same water continuously circulates between the compressor and some form of external heat exchanger. This heat exchanger is in turn cooled either by means of an external water circuit or by the surrounding air. When the water is cooled using another water circuit, a flat plate heat exchanger is used.

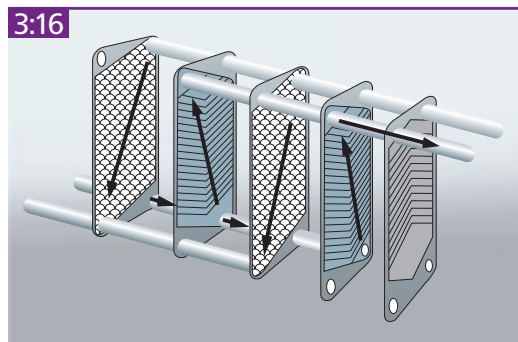
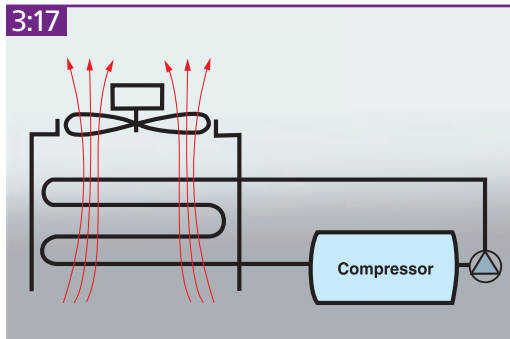

Illustration of a flat heat exchanger. Flat heat exchangers are easy to clean, which makes it possible to indirectly cool the compressor using lake water or stream water.

When the water is cooled using the surrounding air, a cooling matrix consisting of pipes and cooling fins is used. The surrounding air is forced to circulate through the pipes and fins by means of one or more fans. This method is suitable if the availability of cooling water is limited. The cooling capacity of open or closed circuits is about the same, i.e. the compressor water is cooled to 5°C above the coolant temperature. If the cooling water is cooled by the surrounding air, the addition of an anti-freeze (e.g. glycol)



A basic air heater (air cooled heat exchanger) can be found in closed cooling systems for cooling liquids such as water/glycol, oil, etc. In aggressive environments or with aggressive liquids stainless steel or titanium coolers are used.

is required. The closed cooling water system is filled with pure, softened water. When glycol is added, the compressor system's water flow must be recalculated, as the type and concentration of glycol affects the water's thermal capacity and viscosity.

It is also important that the entire system be thoroughly cleaned before being filled for the first time. A correctly implemented closed water system requires very little supervision and has low maintenance costs. For installations in which the available cooling water is potentially corrosive, the cooler should be designed in a corrosion-resistant material such as Incoloy.

3.3.2 Air cooled compressors

Most modern compressor packages are also available in an air-cooled version, whereby the

Freezing point °C	Glycol mixture %	Specific heat capacity kJ/kg x K
-10	23	3.850
-15	30	3.650
-20	37	3.450
-25	43	3.350
± 0	0	4.190

The water must be protected from freezing at low temperatures. Remember that the size of the cooler may need to be increased as, for example, a water/glycol mixture has a lower thermal capacity than pure water.

3:19

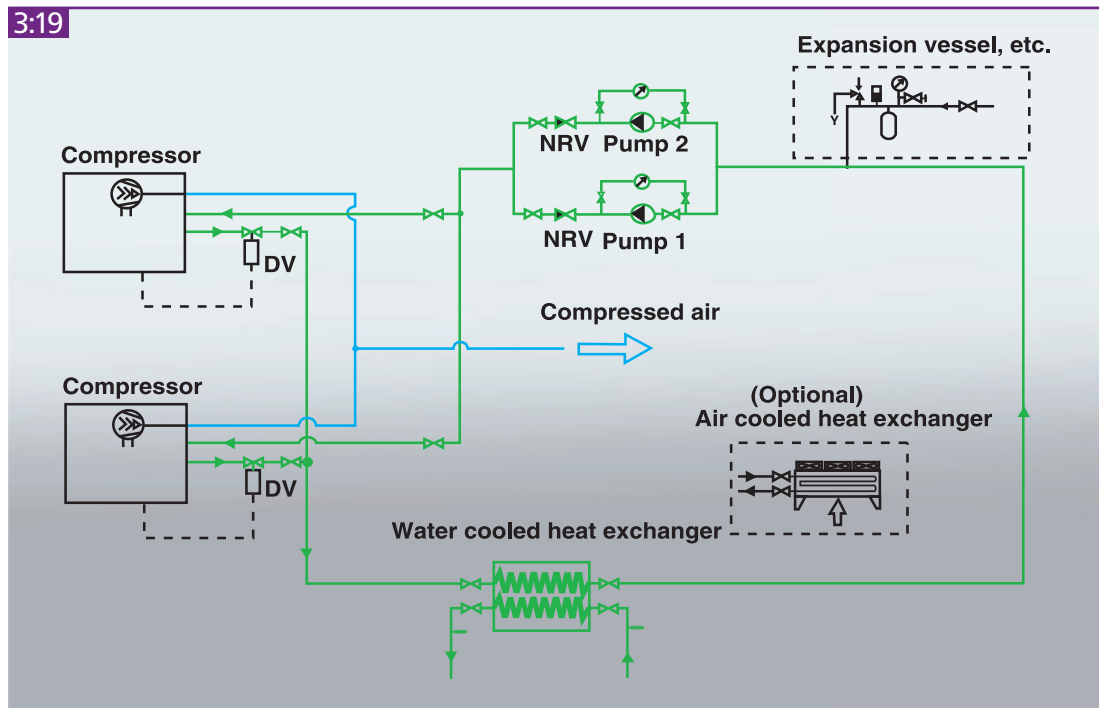

Schematic of a closed cooling system. The heat exchanger can be water cooled or air cooled.

forced ventilation inside the air compressor package contains close to 100% of the energy consumed by the electric motor.

3.4 ENERGY RECOVERY

3.4.1 General

When air is compressed heat is formed. Before the compressed air is distributed into the pipe system the heat energy is extracted, and becomes waste heat. For each compressed air installation, the issue of sufficient and reliable cooling capacity for the installation must be addressed. Cooling can take place either by means of the outdoor air or a cooling water system that uses municipal water, stream water or process water in an open or closed system.

Many installations that produce compressed air offer significant and frequently unutilized energy saving possibilities in the form of waste energy recovery. In large industries, energy costs

can amount to 80% of the total cost of compressed air production. As much as 94% of the energy supplied to the compressor can be recovered, for example, as 90° hot water from oil-free screw compressors. This fact illustrates that saving measures quickly provide substantial return. A compressor central plant in a large industry that consumes 500 kW over 8,000 operating hours per year represents a yearly energy consumption of 4 million kWh. The possibilities for recovering substantial amounts of waste heat via hot air or hot water are real.

The return on investment for energy recovery is usually as short as 1–3 years. In addition, energy recovered by means of a closed cooling system enhances compressor operating conditions, reliability and service life due to an equalized temperature level and high cooling water quality, to name but a few advantages. Nordic countries are somewhat of a forerunner in this arena and energy recovery has been standard practice for quite some time now for compressor installations.

Most medium to large compressors from the major suppliers are now adapted for fitting with standard equipment for waste heat recovery.

3:20

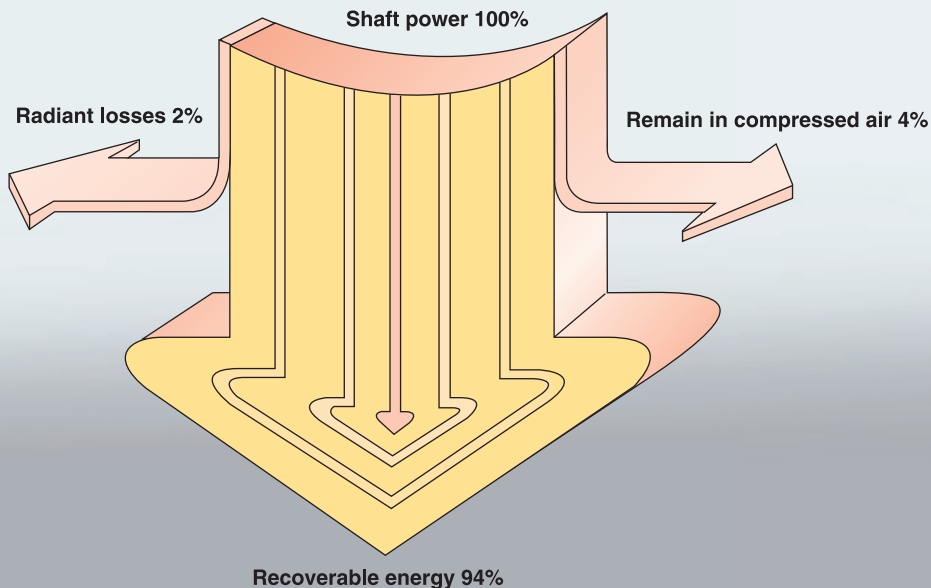

As heat is the unavoidable by-product of compression, energy can be recovered in the form of hot water from the compressor cooling system.

3:21

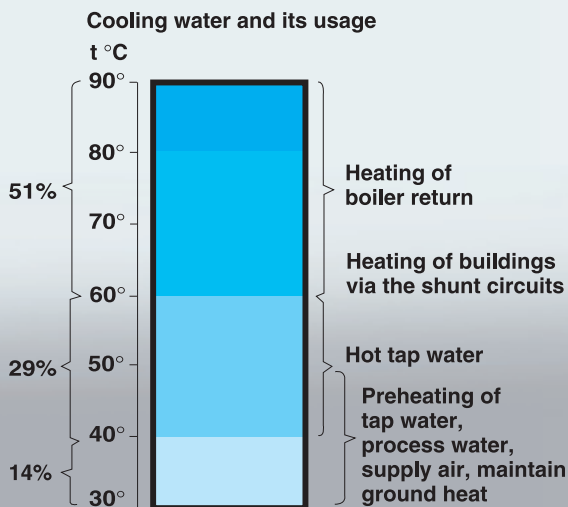
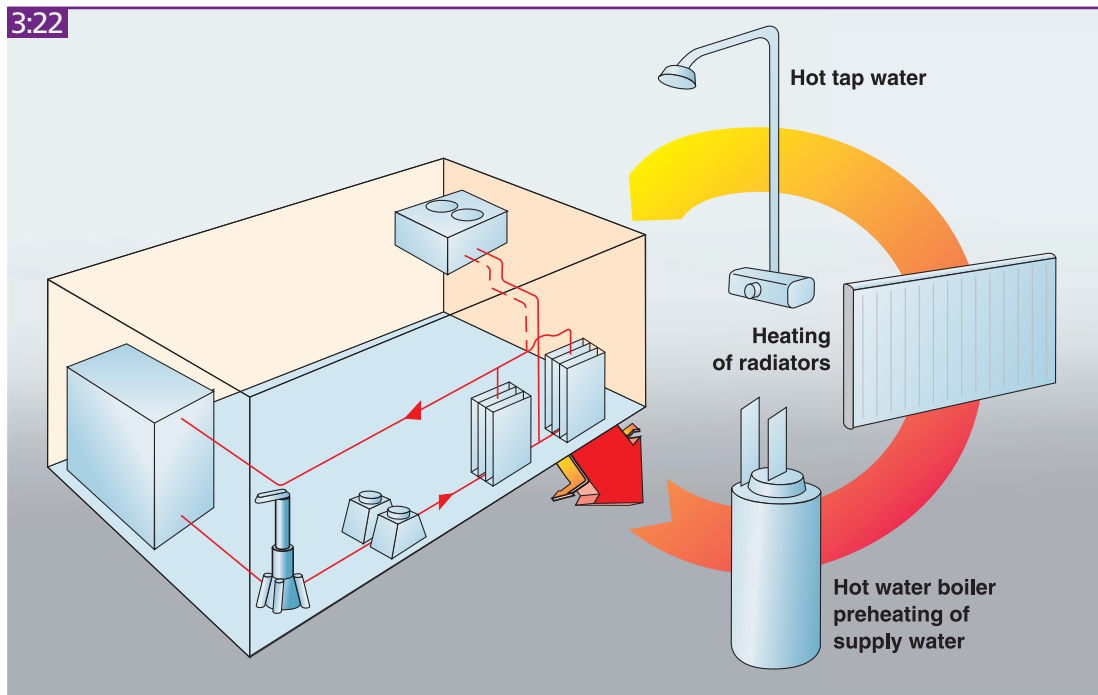

Diagram illustrating some of the typical application areas for energy recovery from the compressor cooling water. At the highest temperature levels the degree of recovery is the greatest.

3:22



Each compressor installation has a large potential for energy recovery. Up to 95% of the supplied energy can be recovered from large, oil-free screw compressors.

3.4.2 Calculation of the recovery potential

The laws of physics dictate that nearly all energy supplied to a compressor installation is converted into heat. The more energy that can be recovered and utilized in other processes, the higher the system's overall efficiency. The quantity of heat that can be recovered can be calculated by the equation:

Recovered energy in kWh/year:

$$W = [(K_1 \times Q_1) + (K_2 \times Q_2)] \times T_R$$

$$\text{Savings per year: (€)} = W \times \frac{e_p}{n}$$

T_R = Time of recovered energy demand
(hrs/year)

K_1 = Part of TR with loaded compressor
(hrs/year)

K_2 = Part of TR with off-loaded compressor
(hrs/year)

Q_1 = Available coolant power with loaded compressor (kW)

Q_2 = Available coolant power with off-loaded compressor (kW)

e_p = Energy price level (€/kWh)

n = Normal heat source efficiency (%)

In many cases the degree of heat recovery can exceed 90% if the energy gained by cooling the compressor installation can be utilized efficiently. The function of the cooling system, the distance to the point of consumption, and the degree and continuity of the heat requirement are all decisive factors.

With large thermal flows, selling the recovered heat energy is a possibility that should not be ignored. The electrical energy supplier could be a potential customer, and investment, sub-order and delivery could readily be negotiated. An opportunity for savings also exists by coordinating energy recovery from several processes.

3:23

Energy recoverable power			
FAD m ³ /min	Heat flow kW	Saving at 2000 oper.hours/year kWh/year	Oil EO1 m ³ /year
6.4	34	68 000	10.0
7.4	40	80 000	11.8
11.4	51	102 000	15.0
14.0	61	122 000	17.9
18.7	92	184 000	27.1
21.6	109	218 000	32.1
23.2	118	236 000	34.7
27.9	137	274 000	40.3
34.8	176	352 000	51.8
43.1	215	430 000	63.2
46.9	235	470 000	68.1
46.5	229	458 000	67.4
51.3	253	506 000	74.7
56.9	284	568 000	83.5
62.9	319	638 000	93.8
69.7	366	732 000	108
75.4	359	718 000	106
83.2	392	784 000	115
103.6	490	980 000	144
124.5	602	1 200 000	177

Example of recovery potential of compressors.

3.4.3 Recovery methods

3.4.3.1 General

Energy recovery from compressed air installations does not always result in heat when it is required and oftentimes, not in sufficient quantities. The quantity of recovered energy will vary over time if the compressor has a variable load. In order for recovery to be feasible, a corresponding relatively stable heat energy demand is needed. Recovered waste heat energy is best utilized to supplement energy supplied to the system, so that the available energy is always utilized when the compressor is operating.

3.4.3.2 Air-cooled system

Options for air-cooled compressors, which produce a high hot air flow rate at a relatively low temperature, are direct building heating or heat

exchanging to a preheating battery. The heated cooling air is then distributed using a fan.

When buildings do not require additional heat, the hot air is evacuated into the atmosphere, either automatically by thermostat control or manually by controlling the air damper. A limiting factor is the distance between the compressors and the building that needs to be heated. This distance should be limited (preferably the distance between adjoining buildings). Furthermore, the possibility of recovery may be limited to the colder periods of the year. Air-borne energy recovery is more common for small- and medium-sized compressors. Recovery of waste heat from compressor air cooling systems results in only small losses from the distribution and requires little investment.

3.4.3.3 Water-cooled system

The cooling water from a water-cooled compressor with a temperature up to 90° can supplement a hot water heating system. If the hot water is used instead for washing, cleaning or showering, a normal base load hot water boiler is still required. The energy recovered from the compressed air system forms a supplementary heat source that reduces the load on the boiler, saves heating fuel and could potentially result in the use of a smaller boiler.

3:24

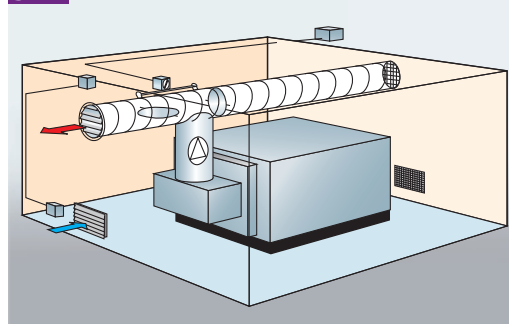

Energy recovery from an air-cooled compressor.

Prerequisites for energy recovery from compressed air compressors differ in part depending on the type of compressor. Standard oil-free compressors are easy to modify for energy recovery. This type of compressor is ideal for integration in a hot water heating system since it provides the water temperature (90°C) required for efficient energy recovery. On oil-lubricated com-

3:25

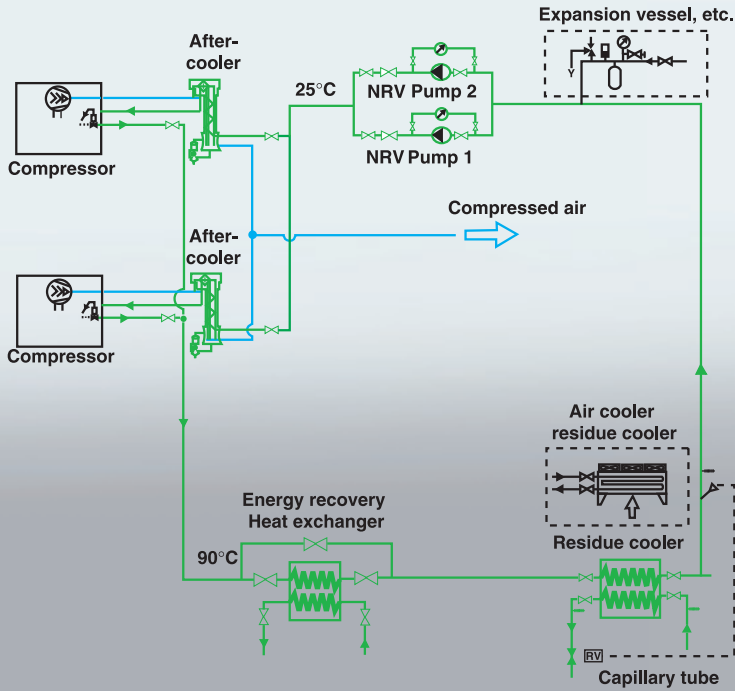

Example of water-borne energy recovery of an oil-free screw compressor.

3:26

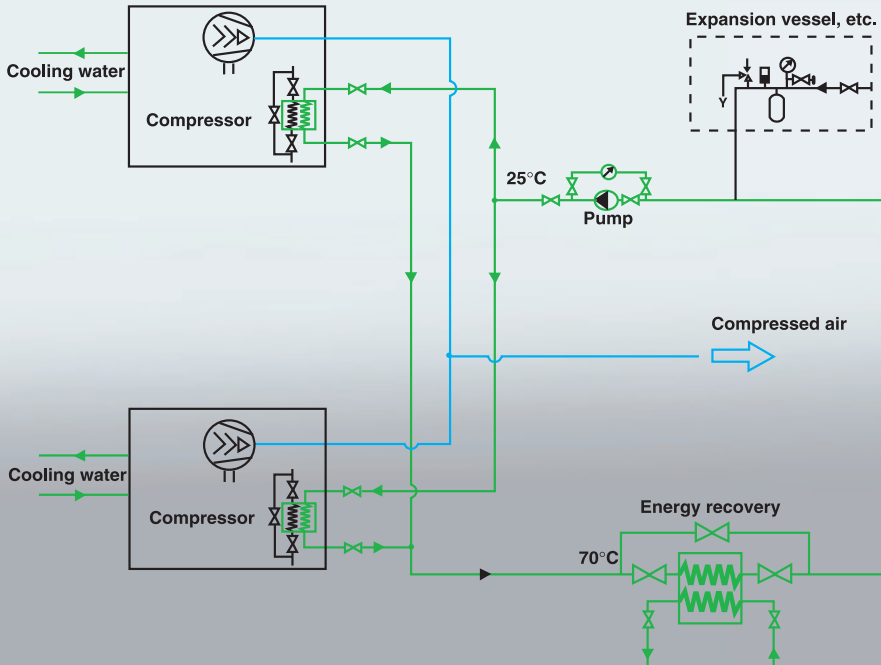

Example of water-borne energy recovery of an oil-lubricated screw compressor. The residue cooler with regulation system is integrated in the compressor.

pressors, the oil, which takes part in the compression process, is a factor that limits the possibilities for high cooling water temperatures.

In centrifugal compressors, the temperature levels are generally lower because of the lower pressure ratio per compression stage, thereby limiting the degree of recovery.

Waterborne waste energy recovery is best suited to compressors with electric motor power over 10 kW. Waterborne recovery of waste energy requires a more complex installation than airborne waste energy recovery. The basic equipment consists of fluid pumps, heat exchangers and regulation valves.

Heat can also be distributed to remote buildings using relatively small pipe diameters (40-80 mm) without significant heat losses using waterborne energy recovery. The high initial water temperature means that waste energy can be used to increase the temperature of the return water from a hot water boiler. Therefore, the normal heating source can be periodically switched off and be replaced by the compressor's waste heat recovery system. Waste heat from compressors in the process industry can also be used to increase the temperature of the process.

It is also possible to use air-cooled oil-lubricated screw compressors to apply water-borne waste energy recovery. This requires a heat exchanger in the oil circuit, and the system will provide water at lower temperatures (50° - 60°) than with oil-free compressors.

3.5 THE COMPRESSOR ROOM

3.5.1 General

Not so long ago, acquiring a compressor required the customer to purchase the electric motor, starter equipment, after-cooler, intake filters, etc. The customer also had to thoroughly examine capacity and quality demands with all of the various component suppliers. This was in order to ensure that all equipment was compatible with the compressor. Today, a compressor and all of its accessories are purchased as a turnkey solution, and quite often as a fully-integrated

package. A compressor package consists of a box frame, on which the compressor and accessories are mounted. All internal connections between the different parts are factory-made. The complete compressor package is enclosed in a sound reducing enclosure to reduce noise levels.

This has resulted in significantly simplifying installation. An extreme example is the so-called 'worksite compressor', which incorporates fully-integrated compressed air conditioning systems (dryer, filter, condensate remover etc.) and highly effective noise and vibration reduction measures. These modern compressor packages are installed along the existing compressed air distribution system or along future expansions thereof. Regardless, it is important to remember that the installation method may still have a significant influence on compressor system performance and reliability.

The main rule for an installation is first and foremost to arrange a separate compressor central plant. Experience dictates that centralization is preferable, regardless of industry. Among other things, it provides improved operating economy, a better-designed compressed air system, service and user friendliness, protection against unauthorized access, proper noise control and simpler possibilities for controlled ventilation.

Secondly, a separate area in a building that is used for other purposes can be used for the compressor installation. Certain risks and inconveniences should be accounted for with this type of installation, for example: disturbance due to noise or the compressor's ventilation requirements, physical risks and/or overheating risks, drainage for condensation, hazardous surroundings e.g. dust or inflammable substances, aggressive substances in the air, space requirements for future expansion and accessibility for service. However, installation in a workshop or warehouse can facilitate the installations for energy recovery. If there are no facilities available for installing the compressor indoors, it may also be installed outdoors, under a roof. In this case, certain issues must be taken into consideration: the risk of freezing for condensation pockets and discharges, rain and snow protection for the air intake opening, suction inlet and ventilation, required solid, flat foundation (asphalt, concrete slab or a flattened bed of shingle), the risk of dust, inflammable or aggressive substances and protection against

3:27

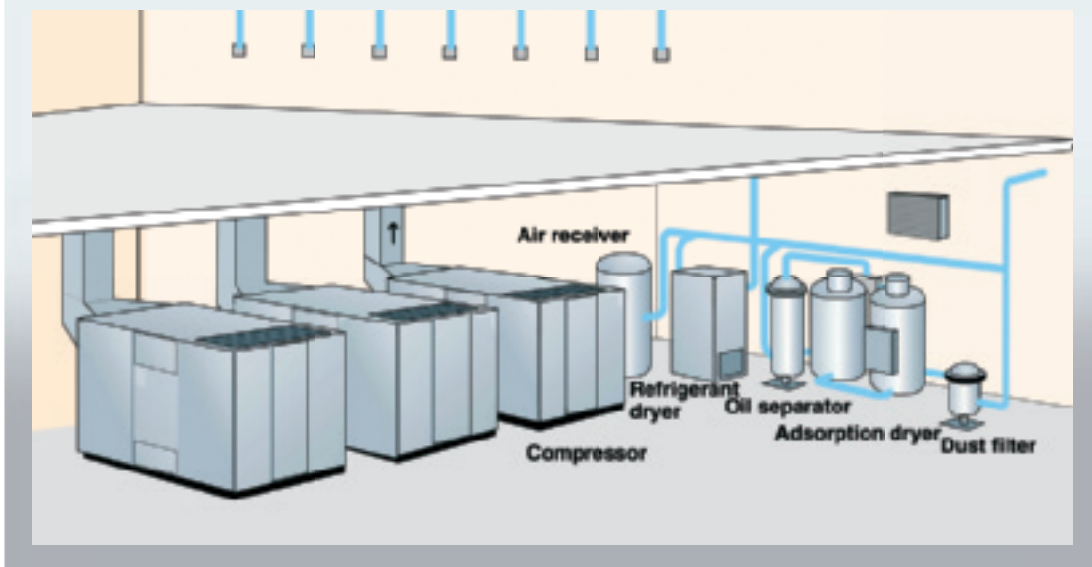

Installation in a compressor room is straightforward. The compressor package is a turnkey solution ready to install and connect to requisite auxiliary equipment.

unauthorized access.

3.5.2 Placement and design

The compressed air plant should be installed to facilitate distribution system routing in large installations with long piping. Service and maintenance can be facilitated by installing the compressed air plant near auxiliary equipment such as pumps and fans; even a location close to the boiler room may be beneficial.

The building should feature lifting equipment that is dimensioned to handle the heaviest components in the compressor installation, (usually the electric motor) and/or have access to a fork-lift truck. It should also have sufficient floor space for installation of an extra compressor for future expansion.

In addition, clearance height must be sufficient to allow an electric motor or similar to be hoisted, should the need arise. The compressed air plant should have a floor drain or other facilities to handle condensation from the compressor, after-cooler, air receiver, dryers etc. The floor drain must be implemented in compliance with municipal legislation.

3.5.3 Foundation

Normally only a flat floor of sufficient weight capacity is required to set up the compressor plant. In most cases, anti-vibration features are integrated in the plant. For new installations, a plinth is usually used for each compressor package in order to allow the floor to be cleaned. Large piston and centrifugal compressors can require a concrete slab foundation, which is anchored to the bedrock or on a solid soil base. The impact of externally-produced vibration has been reduced to a minimum for advanced, complete compressor plants. In systems with centrifugal compressors, it may be necessary to vibration dampen the compressor room's foundation.

3.5.4 Intake air

The compressor's intake air must be clean and free of solid and gaseous contamination. Particles of dirt that cause wear and corrosive gases can be particularly damaging.

The compressor air inlet is usually located at an opening in the sound-reducing enclosure, but can also be placed remotely, in a place in which the air is as clean as possible. Gas contamination

3:28

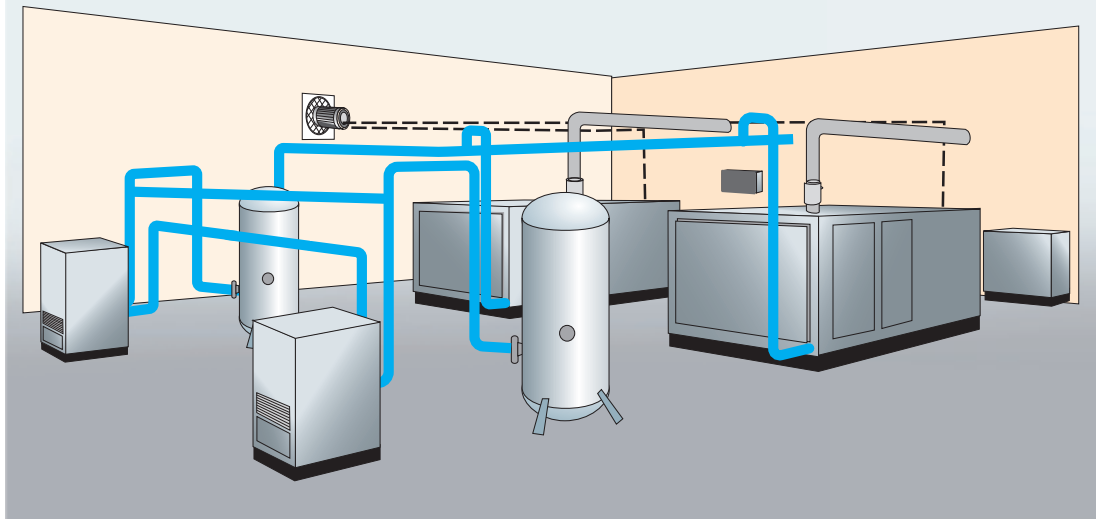

It is important that the compressor installation has a layout that is service friendly and flexible to accommodate future expansion. The minimum area at service points in front of the machine electrical cabinets should be 1200 mm.

from vehicle exhaust fumes can be fatal if mixed with air that is meant to be inhaled. A pre-filter (cyclone, panel or rotary band filter) should be used on installations where the surrounding air has a high dust concentration. In such cases, the pressure drop caused by the pre-filter must be accounted for during design.

It is also beneficial for the intake air to be cold. It may therefore be appropriate to route this air through a separate pipe from the outside of the building into the compressor.

It is important that corrosion-resistant pipes, fitted with mesh over the inlet and designed so that there is no risk of drawing snow or rain into the compressor, be used for this purpose. It is also important to use pipes of a sufficiently large diameter to have as low a pressure drop as possible.

The design of the inlet pipes on piston compressors is particularly critical. Pipe resonance from acoustic standing waves caused by the compressor's cyclic pulsating frequency can damage the piping as well as the compressor, cause vibration and affect the surroundings through irritating low frequency noise.

3.5.5 Compressor room ventilation

Heat in the compressor room is generated from all compressors. This heat is let off by ventilating the compressor room. The quantity of ventilation air is determined by the size of the compressor and whether it is air- or water-cooled.

The ventilation air for air-cooled compressors contains close to 100% of the energy consumed by the electric motor in the form of heat. The

3:29

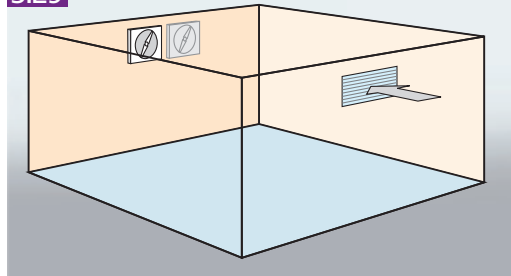

Basic ventilation solution. The disadvantage is that ventilation is constant irrespective of the outside temperature. In addition difficulties can occur if two compressors are installed. The fans will be over-dimensioned if only one of the compressors is used. The problem can be solved by fitting the fans with speed controlled motors, which start via a multi-stage thermostat.

3:30

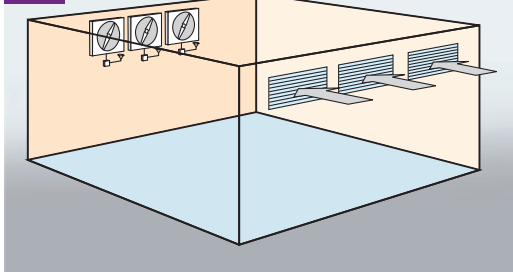

System with several thermostat-controlled fans, which together can handle the total ventilation requirement. The thermostats on the individual fans are set for different ranges, which means that the quantity of ventilation air can vary depending on the outside temperature and/or the number of compressors in use (as the thermostats will switch on the fans one after another depending on the temperature in the compressor room). Alternatively, the fans can be started via a multi-stage thermostat.

ventilation air for water-cooled compressors contains some 10% of the energy consumed by the electric motor. The heat must be removed to maintain the temperature in the compressor room at an acceptable level. The compressor manufacturer should provide detailed information regarding the required ventilation flow, but this figure can also be calculated according to the following:

$$q_v = \frac{P_v}{1.21 \times \Delta T}$$

q_v = quantity of ventilation air (m³/s)

P_v = heat flow (kW)

ΔT = permitted temperature rise (°C)

A better way to deal with the heat build-up problem is to recover the waste heat energy and use it on the premises.

Ventilation air should be taken from outdoors, preferably without using long ducting. Furthermore, the intake should be placed as low as possible, but without running the risk of being covered with snow during the winter. Even risks that dust and explosive or corrosive substances might potentially enter the compressor room must be taken into consideration. The ventilation fan/fans should be placed high up on one of the compressor room's end walls, and the air intake

3:31

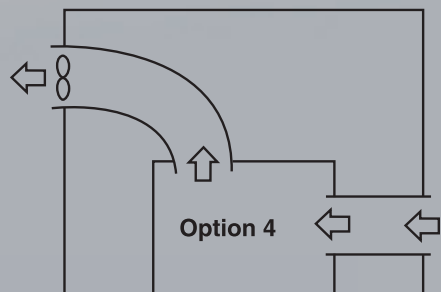
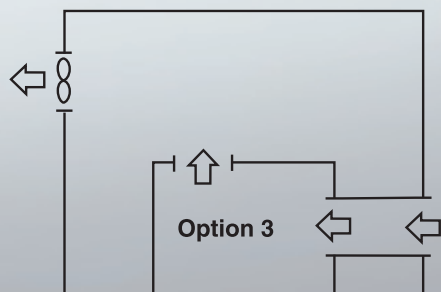
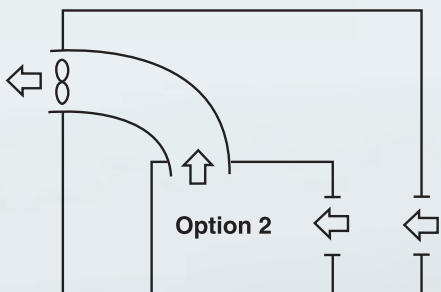
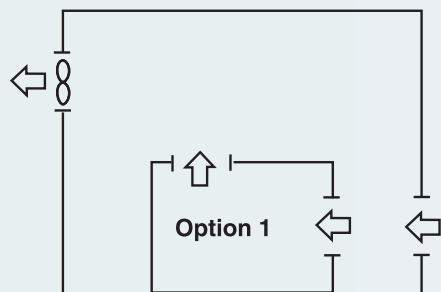

Examples of different ventilation solutions.

3:32

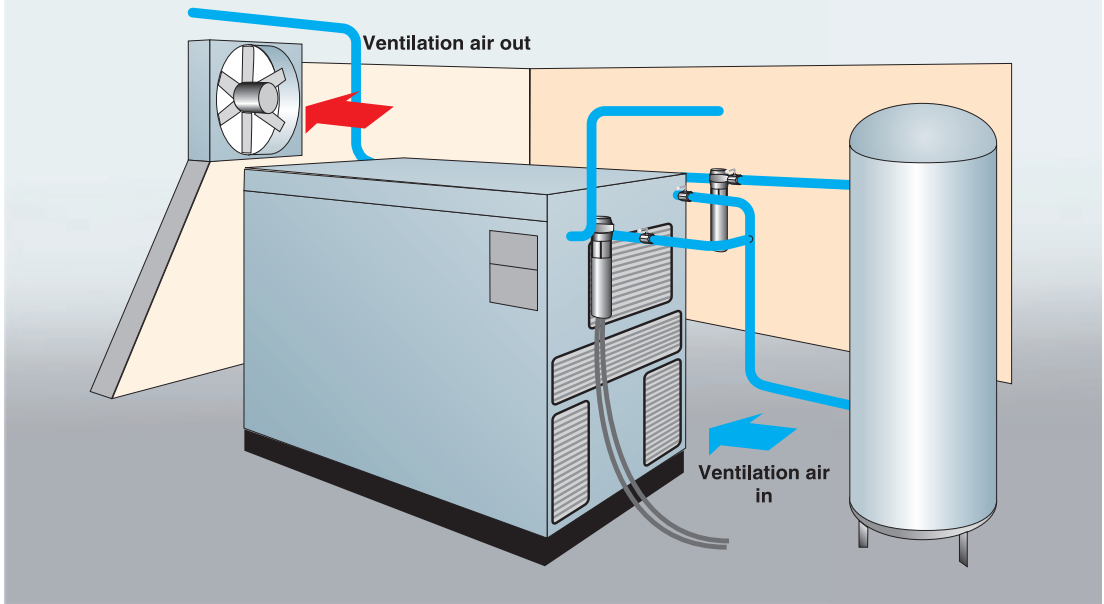

A simple compressor installation in practice. An oil separator must be installed, if there is a risk that the waste condensation water contains oil.

3:33

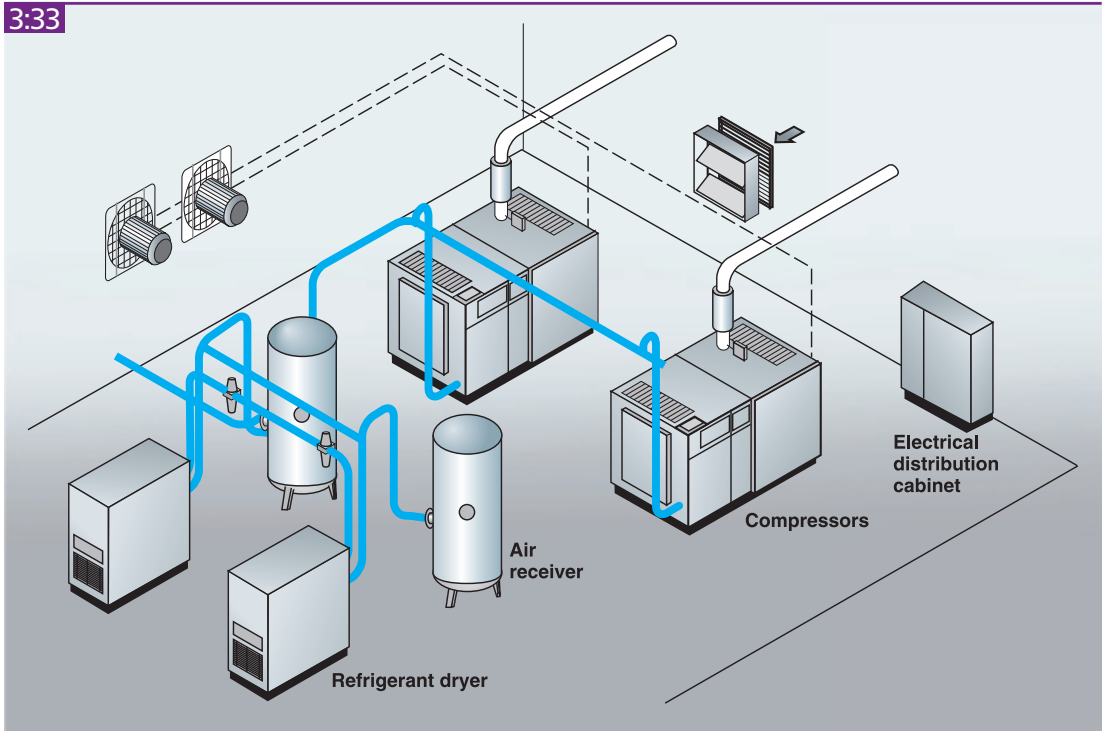

Example of a hospital installation with closed supply on the suction side and 100% redundant system.

placed on the opposite wall. The air velocity at the ventilation inlet opening should not exceed 4 m/s.

Thermostat-controlled fans are the most appropriate in this case. These fans must be dimensioned to handle the pressure drop in the ducting, outer wall louver, etc. The quantity of ventilation air must be sufficient to limit the temperature increase in the room to 7–10°C. The possibility of using water-cooled compressors should be considered if there is a problem procuring sufficient ventilation in the room.

3.5.6 Air Vessel Safety

Steel vessels used for compressed air are always affected by internal corrosion. Therefore, the wall thickness always has a “corrosion allowance” on top of the required shell thickness to ensure a proper lifetime of the vessel.

The reason of the internal corrosion is a complex phenomenon, which is mainly due to the presence of condensing water inside the vessel; internal corrosion is evident on vessels that collect air without an upstream air dryer, but even if there is a dryer corrosion will occur.

External environment (e.g. sulfurs, sea environment) also affect the internal corrosion in a vessel.

A corroded vessel can result in a sudden burst, which in cases has similarities to an explosion.

There is serious risk for people injury and damage to installations.

A frequent draining of the internal condensing water (each 8 hours or at least once a day) is necessary to maintain the vessel in good condition. Several national legislations require a periodical inspection of vessels to be carried out by official inspection bodies or delegated officers. The inspection provides a shell thickness measurement, in order to verify the safety condition of the vessel. Once the shell thickness is lower than a certain limit defined by the vessel manufacturer, the vessel must be taken out of operation. The measurement of the wall thickness is normally done via ultrasonic waves or by direct inspection through the plugs positioned at the end shells.

For the reason of vessel safety, there should never be welding or modifications done to the air vessels.

3:34

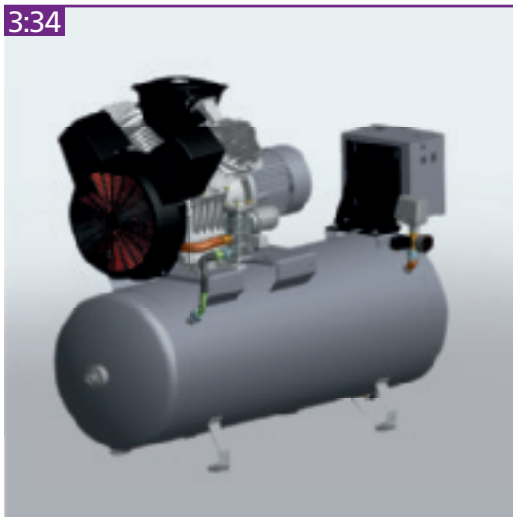

3.6 COMPRESSED AIR DISTRIBUTION

3.6.1 General

Inadequate compressed air distribution systems will lead to high energy bills, low productivity and poor air tool performance. Three demands are placed on a compressed air distribution system: a low pressure drop between the compressor and point of consumption, a minimum of leakage from the distribution piping, and efficient condensate separation if a compressed air dryer is not installed.

This primarily applies to the main pipes, and to the planned compressed air consumption for current needs as well as for the future. The cost of installing larger pipe dimensions as well as fittings than those initially required is low compared to the cost of rebuilding the distribution system at a later date. The air line network's routing, design and dimensioning are important for the efficiency, reliability and cost of compressed air production. Sometimes a large pressure drop in the pipeline is compensated by increasing the working pressure of the compressor from 7 bar(e) to 8 bar(e), for example. This offers inferior compressed air economy. Moreover, when compressed air consumption is reduced, so is the pressure drop and the pressure at the point of consumption consequently rises above the allowed level.

Fixed compressed air distribution networks should be dimensioned so that the pressure drop in the pipes does not exceed 0.1 bar between the compressor and the most remote point of consumption. The pressure drop in connecting flexible hoses, hose couplings and other fittings must be added to this. It is particularly important to properly dimension these components, as the largest pressure drop frequently occurs at such connections.

The longest permitted length in the pipe network for a specific pressure drop can be calculated using the following equation:

$$l = \frac{\Delta p \times d^5 \times p}{450 \times q_c^{1.85}}$$

l = overall pipe length (m)

Δp = permitted pressure drop in the network (bar)

p = absolute inlet pressure (bar(a))

q_c = compressor Free Air Delivery, FAD (l/s)

d = internal pipe diameter (mm)

The best solution involves designing a pipe system as a closed loop ring line around the area in which air consumption will take place. Branch pipes are then run from the loop to the various consumer points. This provides uniform compressed air supply, despite heavy intermittent usage, as the air is led to the actual point of consumption from two directions.

This system should be used for all installations, except if some points of large air consumption are located at a great distance from the compressor installation. A separate main pipe is then routed to these points.

3.6.1.1 Air receiver

One or more air receivers are included in each compressor installation. Their size is a function of the compressor capacity, regulation system and the consumer's air requirement pattern. The air receiver forms a buffer storage area for the compressed air, balances pulsations from the compressor, cools the air and collects condensation. Consequently, the air receiver must be fitted with a condensate drainage device.

The following relation applies when dimensioning the receiver's volume. Note that this relation only applies for compressors with offloading/loading regulation.

3:35

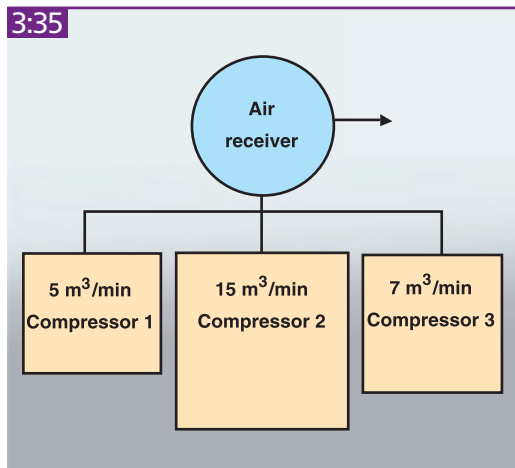

The air receiver is always dimensioned on the basis of the largest compressor when a system contains several compressors.

$$V = \frac{0.25 \times q_c \times p_1 \times T_0}{f_{\max} \times (p_U - p_L) \times T_1}$$

V = air receiver volume (l)

q_c = Compressor FAD (l/s)

p_1 = Compressor inlet pressure (bar(a))

T_1 = Compressor maximum inlet temperature (K)

T_0 = Compressor air temperature in receiver (K)

$(p_U - p_L)$ = set pressure difference between Load and Unload

f_{\max} = maximum loading frequency (1 cycle every 30 seconds applies to Atlas Copco compressors)

For compressors with Variable Speed Control (VSD) the required air receiver volume is substantially reduced. When using the above formula, q_c should be considered as the FAD at minimum speed.

When the demand for compressed air requires large quantities over short periods of time, it is not economically viable to dimension the compressor or pipe network exclusively for this extreme air consumption pattern. A separate air receiver should be placed near the consumer point and dimensioned according to the maximum air output.

In more extreme cases, a smaller, high pressure compressor is used together with a large receiver to meet short-term, high volume air require-

ments at long intervals. Here, the compressor is dimensioned to satisfy mean consumption. The following relation applies for such a receiver:

$$V = \frac{q \times t}{p_1 - p_2} = \frac{L}{p_1 - p_2}$$

V = air receiver volume (l)

q = air flow during emptying phase (l/s)

t = length of the emptying phase (s)

p_1 = normal working pressure in the network (bar)

p_2 = minimum pressure for the consumer's function (bar)

L = filling phase air requirement (1/work cycle)

The formula does not take into consideration the fact that the compressor can supply air during the emptying phase. A common application is starting large ship engines, where the receiver's filling pressure is 30 bar.

3.6.2 Design of the compressed air network

The starting point when designing and dimensioning a compressed air network is an equipment list that details all compressed air consumers, and a diagram indicating their individual locations. The consumers are grouped in logical units and are supplied by the same distribution pipe. The distribution pipe is, in turn, supplied by risers from the compressor plant. A larger compressed air network can be divided into four main parts: risers, distribution pipes, service pipes and compressed air fittings. The risers transport the compressed air from the compressor plant to the consumption area.

Distribution pipes split the air across the distribution area. Service pipes route the air from the distribution pipes to the workplaces.

3.6.3 Dimensioning the compressed air network

The pressure obtained immediately after the compressor can generally never be fully utilized because the distribution of compressed air generates some pressure losses, primarily as friction losses in the pipes. In addition, throttling effects and changes in the direction of flow occur

3:36

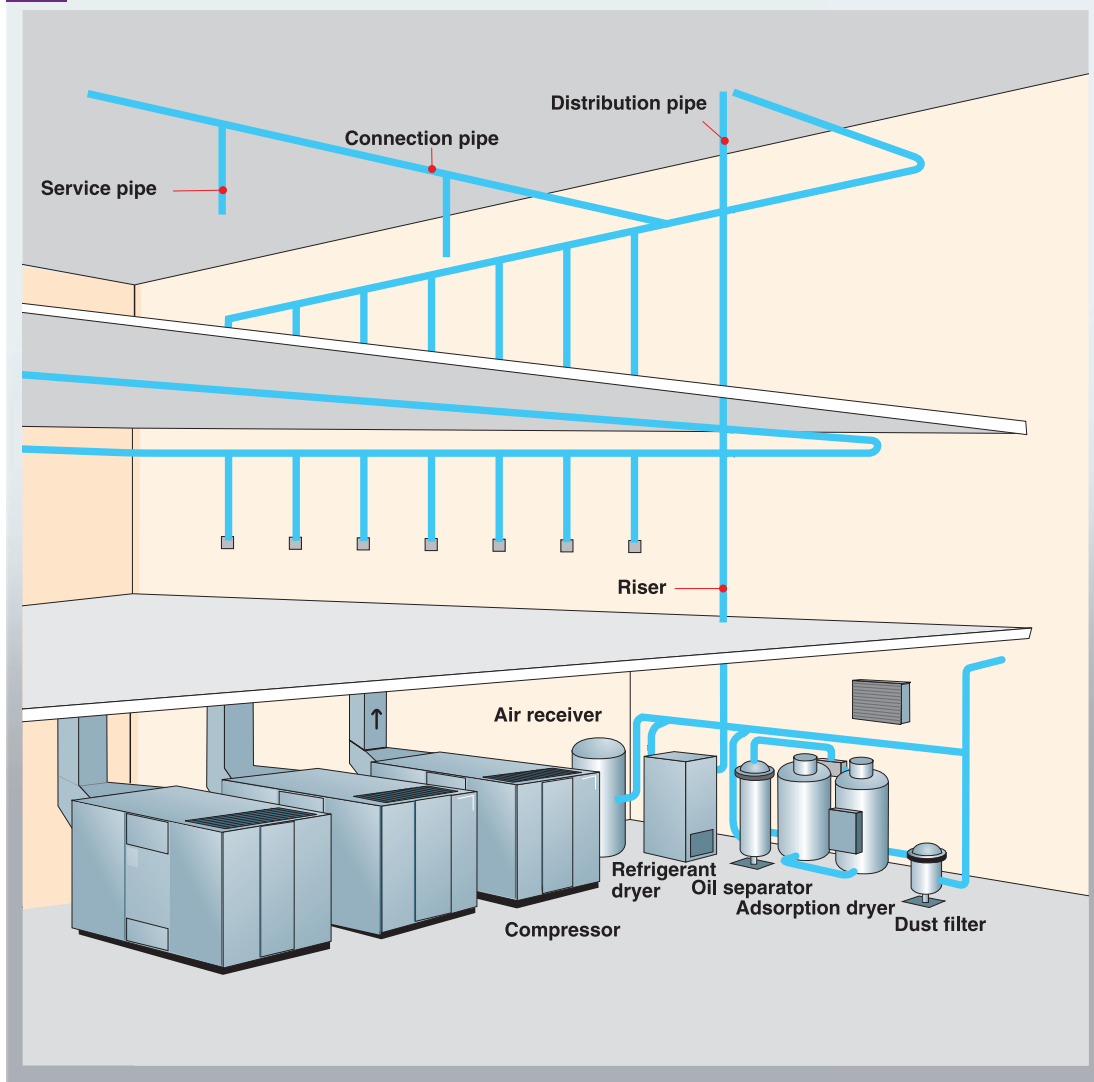

in valves and pipe bends. Losses, which are converted to heat, result in pressure drops that can be calculated using the following equation for a straight pipe:

$$\Delta p = 450 \times \frac{q_c^{1.85} \times l}{d^5 \times p}$$

Δp = pressure drop (bar)

q_c = air flow, FAD (l/s)

d = internal pipe diameter (mm)











l = length of the pipe (m)

p = absolute initial pressure (bar(a))

When calculating different parts of the compressed air network, the following values can be used for the allowed pressure drop:

Pressure drop across service pipes	0.03 bar
Pressure drop across distribution pipes	0.05 bar
Pressure drop across risers	0.02 bar
Total pressure drop across the fixed pipe installation	0.10 bar

3:37

		Equivalent length in meters										
Component		Inner pipe diameter in mm (d)										
		25	40	50	80	100	125	200	250	250	300	400
Ball valve (full flow)		0.3 5	0.5 8	0.6 10	1.0 16	1.3 20	1.6 25	1.9 30	2.6 40	3.2 50	3.9 60	5.2 80
Diaphragm valve fully open		1.5	2.5	3.0	4.5	6	8	10	-	-	-	-
Angle valve fully open		4	6	7	12	15	18	22	30	36	-	-
Poppet valve		7.5	12	15	24	30	38	45	60	-	-	-
Flap check valve		2.0	3.2	4.0	6.4	8.0	10	12	16	20	24	32
Elbow R = 2d		0.3	0.5	0.6	1.0	1.2	1.5	1.8	2.4	3.0	3.6	4.8
Elbow R = d		0.4	0.6	0.8	1.3	1.6	2.0	2.4	3.2	4.0	4.8	6.4
90° angle		1.5	2.4	3.0	4.5	6.0	7.5	9	12	15	18	24
Tee through-flow		0.3	0.4	1.0	1.6	2.0	2.5	3	4	5	6	8
Tee side-flow		1.5	2.4	3.0	4.8	6.0	7.5	9	12	15	18	24
Reducing nipple		0.5	0.7	1.0	2.0	2.5	3.1	3.6	4.8	6.0	7.2	9.6

Some fittings and their influence on losses in pipes of various diameters. The losses are recalculated to a corresponding equivalent length of the pipe (m).

The required pipe lengths for the different parts of the network (risers, distribution and service pipes) are determined. A scale drawing of the probable network plan is a suitable basis for this. The length of the pipe is corrected through the addition of equivalent pipe lengths for valves, pipe bends, unions etc. as illustrated in Figure 3:36.

As an alternative to the above formula, when calculating the pipe diameter, a nomogram (shown in Figure 3:37) can be used to find the most appropriate pipe diameter. The flow rate, pres-

sure, allowed pressure drop and the pipe length must be known in order to make this calculation. Standard pipe of the closest, largest diameter is then selected for the installation.

The equivalent pipe lengths for all the parts of the installation are calculated using a list of fittings and pipe components, as well as the flow resistance expressed in equivalent pipe length. These "extra" pipe lengths are added to the initial straight pipe length. The network's selected dimensions are then recalculated to ensure that the pressure drop will not be too significant. The

3:38

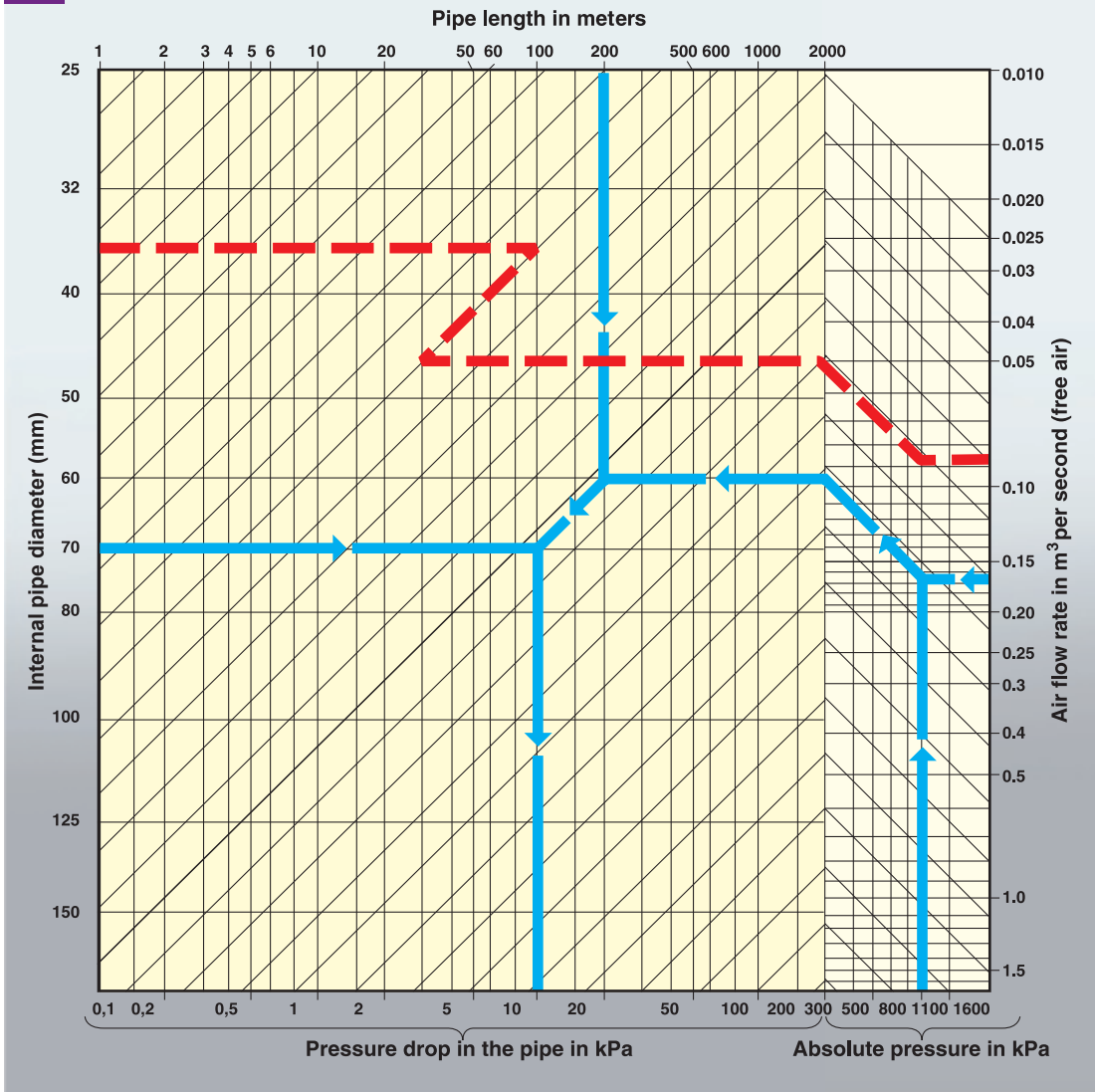

individual sections (service pipe, distribution pipe and risers) should be calculated separately for large installations.

3.6.4 Flow measurement

Strategically placed air flowmeters facilitate internal debiting and economic allocation of compressed air utilization within the company. Compressed air is a production medium that should be a part of the production cost for individual departments within the company. From this viewpoint, all parties concerned could benefit from attempts at reducing consumption

within the different departments.

Flowmeters available on the market today provide everything from numerical values for manual reading, to measurement data fed directly to a computer or debiting module.

These flowmeters are generally mounted close to shut-off valves. Ring measurement requires particular attention, as the meter needs to be able to measure both forward and backward flow.

3.7 ELECTRICAL INSTALLATION

3.7.1 General

To dimension and install a compressor requires knowledge of how component parts affect each other and which regulations and provisions apply.

The following is an overview of the parameters that should be considered to obtain a compressor installation that functions satisfactorily with regard to the electrical system.

3.7.2 Motors

For the most part, three-phase squirrel cage induction motors are used for compressor operations. Low voltage motors are generally used up to 450 – 500 kW, whereas for higher power, high voltage motors are the best option.

The motor protection class is regulated by standards. The dust and water jet-resistant design (IP55) is preferred over open motors (IP23), which may require regular disassembly and cleaning. In other cases, dust deposits in the machine will eventually cause overheating, resulting in shortened service life. Since the compressor package enclosure provides a first line protection from dust and water, a protection class below IP55 may also be used.

The motor, usually fan-cooled, is selected to work at a maximum ambient temperature of 40°C and an altitude of up to 1000 m. Some manufacturers offer standard motors with maximum ambient temperature capability of 46°C. At higher temperatures or higher altitude, the output must be derated. The motor is usually flange-mounted and directly connected to the compressor. The speed is adapted to the type of compressor, but in practice, only 2-pole or 4-pole motors with respective speeds of 3,000 rpm and 1,500 rpm are used.

The rated output of the motor is also determined by the compressor, and should be as close to the compressor's requirement as possible.

A motor that is overdimensioned is more expensive, requires an unnecessarily high starting current, requires larger fuses, has a low power fac-

tor and provides somewhat inferior efficiency. A motor that is too small for the installation in which it is used is soon overloaded and is consequently at risk for breakdowns.

The starting method should also be included as a parameter when selecting a motor. The motor is only started with a third of its normal starting torque for a star/delta-start. Therefore, a comparison of the motor and compressor torque curves may be useful to guarantee proper compressor starts.

3.7.3 Starting methods

The most common starting methods are direct start, star/delta-start and soft start. Direct start is simple and only requires a contactor and overload protection. The disadvantage it presents is its the high starting current, which is 6–10 times the motor's rated current, and its high starting torque, which may, for example, damage shafts and couplings.

The star/delta-start is used to limit the starting current. The starter consists of three contactors, overload protection and a timer. The motor is started with the star connection and after a set time (when the speed has reached 90% of the rated speed), the timer switches the contactors so that the motor is delta-connected, which is the operating mode. (For further details, see Section 1.6.5.7.)

The star/delta-start reduces the starting current to approximately 1/3 as compared to the direct start. However, at the same time, the starting torque also drops to 1/3. The relatively low start-

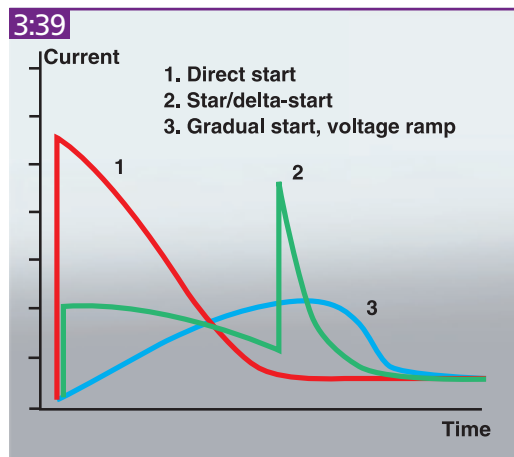

Starting current with different starting methods.

ing torque means that the motor's load should be low during the starting phase, so that the motor virtually reaches its rated speed before switching to the delta connection. If the speed is too low, a current/torque peak as large as with a direct start will be generated when switching to the delta connection.

Soft start (or gradual start), which can be an alternative start method to the star/delta-start, is a starter composed of semiconductors (IGBT-type power switches) instead of mechanical contactors. The start is gradual and the starting current is limited to approximately three times the rated current.

The starters for direct start and star/delta-start are, in most cases, integrated in the compressor. For a large compressor plant, the units may be placed separately in the switchgear, due to space requirements, heat development and access for service.

A starter for soft start is usually positioned separately, next to the compressor, due to heat radiation, but may be integrated inside the compressor package, provided the cooling system has been properly secured. High-voltage powered compressors always have their start equipment in a separate electrical cabinet.

3.7.4 Control voltage

No separate control voltage is usually connected to the compressor, as most compressors are fitted with an integrated control transformer. The transformer's primary end is connected to the compressor's power supply. This arrangement offers more reliable operation. In the event of disturbances in the power supply, the compressor will be stopped immediately and prevented from restarting.

This function, with one internally-fed control voltage, should be used in situations in which the starter is located at a distance from the compressor.

3.7.5 Short-circuit protection

Short-circuit protection, which is placed on one of the cables' starting points, can include fuses or a circuit breaker. Regardless of the solution you select, if it is correctly matched to the system, it will provide the proper level of protection.

Both methods present advantages and disadvantages. Fuses are well-known and work bet-

ter than a circuit-breaker for large short-circuit currents, but they do not create a fully-isolating break, and have long tripping times for small fault currents. A circuit-breaker creates a quick and fully-isolating break, even for small fault currents, but demands more work during the planning stage, as compared to fuses. Dimensioning short-circuit protection is based on the expected load, but also on the limitations of the starter unit.

For starter short-circuit protection, see the IEC (International Electrotechnical Commission) standard 60947-4-1 Type 1 & Type 2. The selection of Type 1 or Type 2 is based on how a short-circuit will affect the starter.

Type 1: "... under short circuit conditions, the contactor or starter shall cause no danger to persons or installation and may not be suitable for further service without repair and replacement of parts."

Type 2: "... under short circuit conditions, the contactor or starter shall cause no danger to persons or installation and shall be suitable for further use. The risk of light welding of the contactors is recognized, in which case the manufacturer shall indicate the maintenance measures ..."

3.7.6 Cables

Cables shall, according to the provisions of the standard, "be dimensioned so that during normal operations they do not experience excessive temperatures and that they shall not be damaged thermally or mechanically by an electric short-circuit". The dimensioning and selection of cables is based on the load, allowed voltage drop, routing method (on a rack, wall etc.) and ambient temperature. Fuses can be used, for example, to protect the cables and can be used for both short-circuit protection and overload protection. For motor operations, short-circuit protection is used (e.g. fuses) as well as separate overload protection (usually the motor protection included in the starter).

Overload protection protects the motor and motor cables by tripping and breaking the starter when the load current exceeds a preset value. The short-circuit protection protects the starter, overload protection and the cables. Cable

3:40

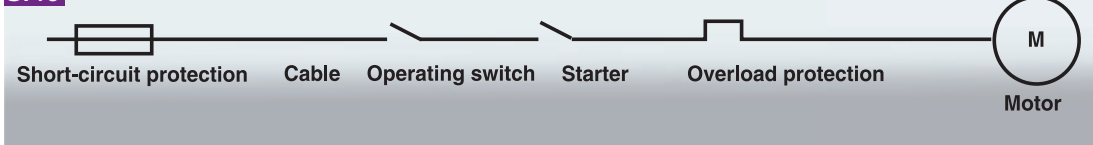

Simplified schematic for electric motor connection to mains power supply.

dimensioning accounting for load is set out in IEC 60364-5-52.

An additional parameter must be kept in mind when dimensioning cables and short-circuit protection: the “tripping condition”. This condition signifies that the installation must be designed so that a short-circuit anywhere in the installation will result in quick and safe breaking. Whether the condition is met is determined by, among other things, the short-circuit protection and the cable length and cross-section.

3.7.7 Phase compensation

The electric motor does not only consume active power, which can be converted into mechanical work, but also reactive power, which is needed for the motor’s magnetization. The reactive power loads the cables and transformer. The relationship between the active and reactive power is determined by the power factor, $\cos \phi$. This is usually between 0.7 and 0.9, where the lower value refers to small motors.

The power factor can be raised to virtually 1 by generating the reactive power directly by the machine using a capacitor. This reduces the need for drawing reactive power from the mains. The reason behind phase compensation is that the

3:41

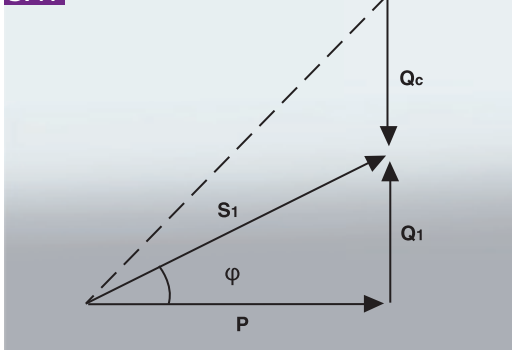

Reactive power Q_c is supplied to increase the motor power factor $\cos(\phi)$ to 1.

power supplier may charge for drawing reactive power over a predetermined level, and that heavily loaded transformers and cables need to be off-loaded.

3.8 SOUND

3.8.1 General

All machines generate sound and vibration. Sound is an energy form that propagates as longitudinal waves through the air, which is an elastic medium. The sound wave causes small changes in the ambient air pressure, which can be registered by a pressure sensitive instrument (e.g. a microphone.)

A sound source radiates sound power and this results in a sound pressure fluctuation in the air. Sound power is the cause of this. Sound pressure is the effect. Consider the following analogy: an electric heater radiates heat into a room and a temperature change occurs. The temperature change in the room is obviously dependent on the room itself. But, for the same electrical power input, the heater radiates the same power, which is almost independent of the environment. The relationship between sound power and sound pressure is similar. What we hear is sound pressure, but this pressure is caused by the sound power of the sound source.

Sound power is expressed in Watts. The sound power level is expressed in decibels (dB), i.e. a logarithmic scale (dB scale) with respect to a reference value that is standardized:

$$L_w = 10 \times \log\left(\frac{W}{W_0}\right)$$

L_w = sound power level (dB)

W = actual sound power (W)

W_0 = reference sound power (10^{-12} W)

The sound pressure is expressed in Pa. The sound pressure level is equally expressed in decibels (dB), i.e. a logarithmic scale (dB scale) with respect to a reference value that is standardized:

$$L_p = 10 \times \log\left(\frac{p^2}{p_0^2}\right) = 20 \times \log\left(\frac{p}{p_0}\right)$$

L_p = sound pressure level (dB)

p = actual sound pressure (Pa)

p_0 = reference sound pressure (20×10^{-6} Pa)

The sound pressure that we observe is dependent on the distance from the source and on the acoustic environment in which the sound wave is propagated. For indoor noise propagation, it therefore depends on the size of the room and on the sound absorption of the surfaces. Consequently, the noise emitted by a machine cannot be fully quantified by exclusively measuring sound pressure. Sound power is more or less independent of the environment, whereas sound pressure is not.

Information about the sound pressure level must thus always be supplemented with additional information: the distance of the measurement position from the sound source (e.g. specified according to a certain standard) and the Room Constant for the room in which the measurement was made. Otherwise, the room is assumed to be limitless (i.e. an open field.) In a limitless room, there are no walls to reflect the sound waves, thereby impacting the measurement.

3.8.2 Absorption

When sound waves come into contact with a surface, a portion of the waves are reflected and another portion is absorbed into the surface material. The sound pressure at a given moment therefore always partly consists of the sound that the sound source generates, and partly of the sound that is reflected of surrounding surfaces (after one or more reflections).

How effectively a surface can absorb sound depends on the material of which it is composed. This is usually expressed as an absorption factor (between 0 and 1, with 0 being completely reflecting and 1 being completely absorbing).

3.8.3 Room Constant

The impact of a room on the propagation of sound waves is determined by the Room Constant. A Room Constant for a room having several surfaces, walls and other inside surfaces can be calculated by taking into account the sizes and absorption characteristics of the various surfaces. The equation that applies is:

$$K = \frac{A \times \bar{\alpha}}{1 - \bar{\alpha}}$$

$$\bar{\alpha} = \frac{\text{total absorption}}{\text{total surface area}}$$

$$\bar{\alpha} = \frac{A_1 \times \alpha_1 + A_2 \times \alpha_2 + \dots}{A_1 + A_2 + \dots}$$

K = Room Constant

$\bar{\alpha}$ = average absorption factor of the room

A = total room surface area (m^2)

A_1, A_2 etc. are the individual room surfaces that have absorption factors α_1, α_2 etc.

3.8.4 Reverberation

A Room Constant can also be determined using the measured reverberation time. The reverberation time T is defined as the time it takes for the sound pressure to decrease by 60 dB once the sound source has been shut off. The average absorption factor for the room is then calculated as:

$$\bar{\alpha} = \frac{0.163 \times V}{T}$$

V = volume of the room (m^3)

T = reverberation time (s)

The Room Constant K is then obtained from the expression:

$$K = \frac{A \times \bar{\alpha}}{1 - \bar{\alpha}}$$

A = total room surface area (m^2)

Absorption coefficients for different surface materials are frequency-dependant and are therefore the derived reverberation time and the room constant.

3.8.5 Relationship between sound power level and sound pressure level

Under some particular conditions, the relationship between sound power level and sound pressure level can be expressed in a simple manner.

If sound is emitted from a point-like sound source inside a room without any reflecting surfaces or outdoors where no walls are close to the sound source, the sound is distributed equally in all directions and the measured sound intensity will therefore be the same at any point with the same distance from the sound source. Accordingly, the intensity is constant at all points on a spherical surface surrounding the sound source.

When the distance to the source is doubled, then the spherical surface at that distance will have quadrupled. From this, we can infer that the sound pressure level falls by 6 dB each time the distance to the sound source is doubled. However, this does not apply if the room has hard, reflective walls. If this is the case, the sound reflected by the walls must be taken into account.

$$L_p = L_w + 10 \times \log\left(\frac{Q}{4\pi r^2}\right)$$

L_p = sound pressure level (dB)

L_w = sound power level (dB)

Q = direction factor

r = distance to the sound source

For Q, the empirical values may be used (for other positions of the sound source the value of Q must be estimated):

Q=1	If the sound source is suspended in the middle of a large room.
Q=2	If the sound source is placed close to the center of a hard, reflective wall.
Q=4	If the sound source is placed close to the intersection of two walls.
Q=8	If the sound source is placed close to a corner (intersection of three walls).

If the sound source is placed in a room where the border surfaces do not absorb all the sound, the sound pressure level will increase due to the

reverberation effect. This increase is inversely proportional to the Room Constant:

$$L_p = L_w + 10 \times \log\left(\frac{Q}{4\pi r^2} + \frac{4}{K}\right)$$

In the proximity of the power source, the sound pressure level drops by 6 dB each time the distance is doubled. However, at greater distances from the source, the sound pressure level is dominated by the reflected sound, and therefore, the decrease is minimal with increasing distance.

Machines which transmit sound through their bodies or frames do not behave as point sources if the listener is at a distance from the centre of the machine that is smaller than 2–3 times the machine's greatest dimension.

3.8.6 Sound measurements

The human ear distinguishes sound at different frequencies with different perception efficiency. Low frequencies or very high frequencies are perceived less intensely than frequencies at around 1000–2000 Hz. Different standardized filters adjust the measured levels at low and high frequencies to emulate the human ear's ability to hear sounds. When measuring occupational and industrial noise, the A-filter is commonly used and the sound level is expressed as dB(A).

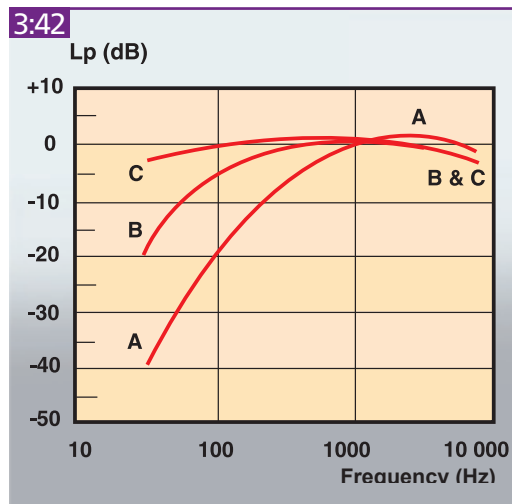

Frequency dependency of the different filters used to weight sound levels when measuring sound. Most common is the A-filter.

3.8.7 Interaction of several sound sources

When more than one sound source emits sound toward a common receiver, the sound pressure increases. However, because sound levels are defined logarithmically, they cannot simply be added algebraically. When more than two sound sources are active, two are first added together, and the next is then added to the sum of the first, and so on. For memory, when two sound sources with the same levels must be added, the result is an increase of 3 dB. The formula for adding two sound levels (sound pressure levels as well as sound power levels) is as follows:

$$L_p(\text{sum}) = 10 \times \log(10^{L_p(1)} + 10^{L_p(2)})$$

A similar formula applies to subtracting sound levels.

3:43

Difference between sound sources (dB)	Addition to the most powerful sound sources (dB)
0	3
1	2.5
2	2.0
3	1.5
4	1.0
5	0.8
6	0.6
7	0.5
8	0.4
9	0.3
10	0.2
11	0.2
12	0.1
13	0.1
14	0.1
15	0.1

The nomogram defines how many dB shall be added to the highest sound level when adding two sound levels.

3:44

Difference between the total sound level and background sound	Deduction from the total sound level (dB)
3	3
4	2
5	1.5
6	1
7	0.75
8	0.5
9	0.4
10	0.3
11	0.2
12	0.2
13	0.1
14	0.1
15	0.1

The nomogram defines how many dB shall be deducted from the total sound level at different background sound levels in order to estimate the net sound level.

Background sound is a special case, which requires subtraction. Background sound is treated as a separate sound source and the value is deducted from the measured sound level.

3.8.8 Sound reduction

There are five different ways to reduce sound. Sound insulation, sound absorption, vibration insulation, vibration dampening and dampening of the sound source.

Sound insulation involves an acoustic barrier being placed between the sound source and the receiver. This means that only a part of the sound can be insulated, depending on the area of the barrier and its insulation characteristics. A heavier and larger barrier is more effective than a lighter, smaller barrier.

Sound absorption involves the sound source being surrounded by light, porous absorbents attached to a barrier. Thicker absorbents are more effective than thinner absorbents and typi-

cal minimum densities are approx. 30 kg/m^3 for open-cell polyurethane foam and approx. 150 kg/m^3 for mineral wool.

Vibration insulation is used to prevent the transfer of vibrations from one part of a structure to another. A common problem is the transfer of vibrations from a built-in machine to the surrounding sound insulation barrier or down to the floor. Steel springs, air springs, cork, plastic, and rubber are examples of materials used for vibration insulation. The choice of materials and their dimensioning is determined by the frequency of the vibration and by the demands of stability for the machine setup.

Vibration dampening involves a structure being fitted with an external dampening surface composed of elastic material with a high hysteresis. When the dampening surface applied is sufficiently thick, the barrier wall will effectively be prevented from vibrating and, consequently, from emitting sound.

Dampening of a sound source will often influence its operational behavior. It may give limited results, yet provide a viable solution in terms of cost.

3.8.9 Noise within compressor installations

Compressor noise level is measured in a standardized fashion on a machine (in an acoustic free field e.g. outdoors, without walls or by means of a sound intensity scanning technique). When the compressor is installed in a room, the noise level is influenced by the properties of the room. The size of the room, the materials used for the walls and ceiling, and the presence of other equipment (and its potential noise levels) in the room all have significant impacts.

Furthermore, the positioning of the compressor in the room also affects the noise level due to the setup and connection of pipes and other components. Sound radiating from compressed air pipes is frequently more problematic than the noise produced by the compressor itself and its power source. This can be due to vibration transferred mechanically to the pipes, often in combination with vibration transferred through the compressed air. It is therefore important to fit vibration insulators and even enclose sections of the pipe system using a combination of sound-absorbing material covered with a sealed insulation barrier.

4 ECONOMY

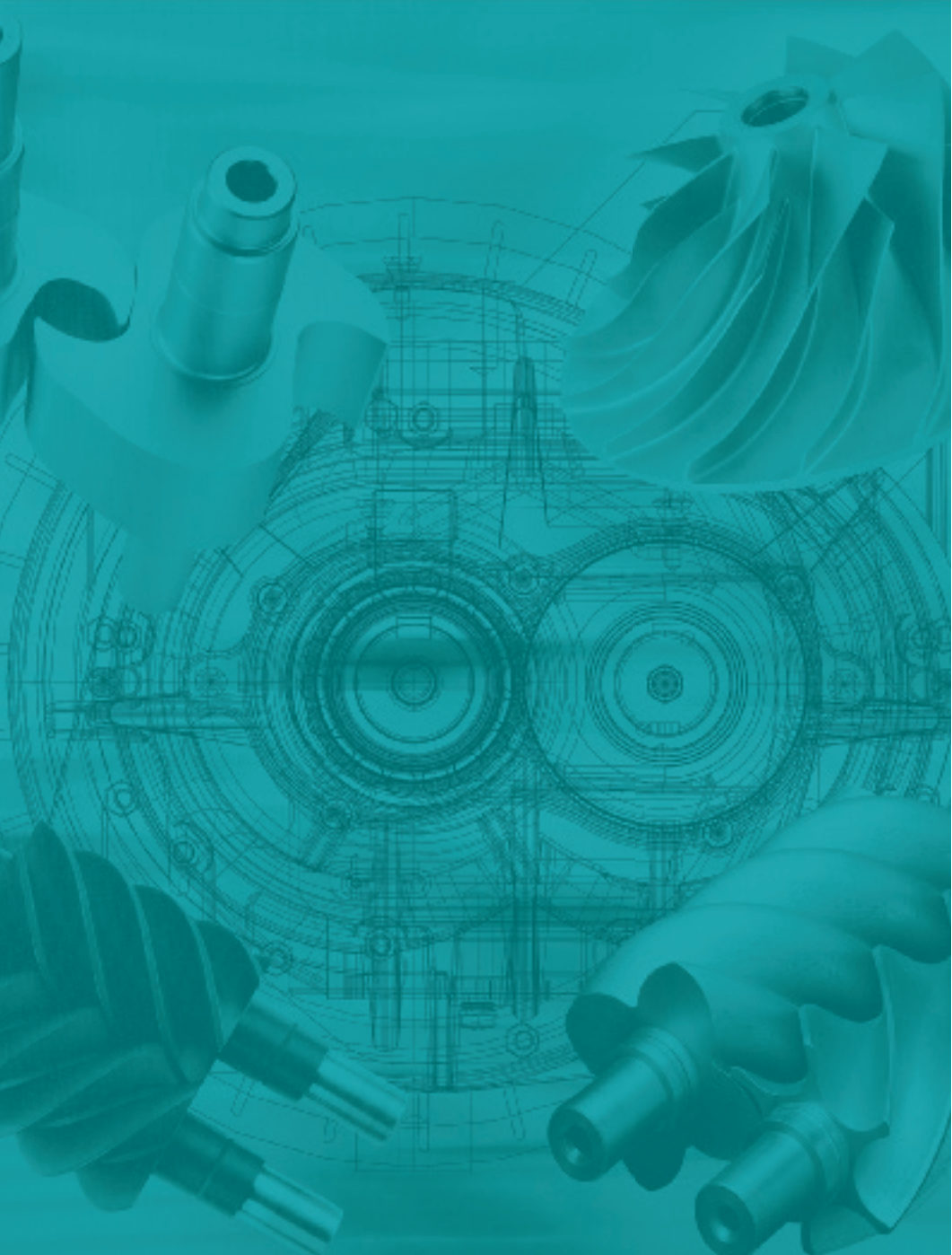

4.1 COST

4.1.1 Compressed air production cost

4.1.1.1 General

Electrical energy is the most prevalent energy source for industrial compressed air production. In many compressed air installations there are often significant and unutilized energy-saving possibilities including energy recovery, pressure reduction, leakage reduction and optimization of operations through correct choice of a control and regulation system as well as the choice of compressor size.

When planning a new investment, it is best to look as far into the future as possible and attempt to assess the impacts of new situations and demands that might affect the compressed air installation. Typical examples include environmental demands, energy-saving demands, increased quality requirements from production and future production expansion investments. Optimized compressor operations are becoming more important, especially for larger, compressed air-dependent industries. Production will change over time in a developing industry and, consequently, so will compressor operation conditions. It is therefore important that the compressed air supply be based both on current

requirements as well as on development plans for the future. Experience shows that an extensive and unbiased analysis of the operating situation will almost always result in improved overall economy.

Energy costs are clearly the dominating factor for the installation's overall cost. It is therefore important to focus on finding solutions that comply with demands for performance and quality as well as the demand for efficient energy utilization. The added cost associated with acquiring compressors and other equipment that complies with both of these demands will be perceived over time as a good investment.

As energy consumption often represents approx. 80% of the overall cost, care should be taken in selecting the regulation system. The significant difference in the available regulation systems exceeds the significant differences in types of compressor. An ideal situation is when compressor full capacity is precisely matched to the application's air consumption. This frequently occurs in process applications. Most types of compressors are supplied with their own on-board control and regulation system, but the addition of equipment for shared control with other compressors in the installation can further improve operating economy.

Speed regulation has proven to be a popular regulation method because of its substantial energy-saving potential. Think carefully and allow your application requirements to govern your selection of regulation equipment in order to obtain good results.

If only a small amount of compressed air is required during the night and weekends, it may be profitable to install a small compressor adapted to this off-peak requirement. If, for some reason, a particular application needs a different working pressure, this requirement should be analyzed to find out whether all compressed air production should be centralized in a compressor central plant, or whether the network should be split up according to the different pressure levels. Sectioning of the compressed air network can also be considered to shut down certain sections during the night and on the weekends, in order to reduce air consumption or to allocate costs internally based on air flow measurements.

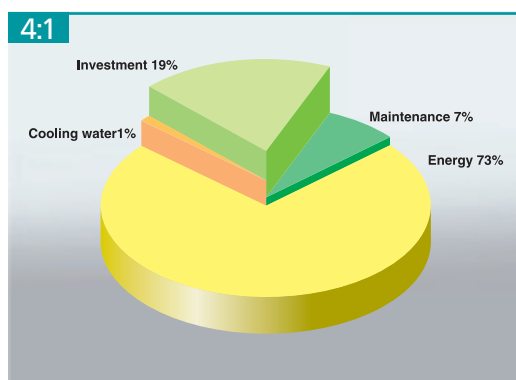

When analyzing the cost contributors to the production of compressed air one will find a breakdown similar to the one in the diagram. However, the relative weight of the different types of costs may change with the number of operating hours/year, with the auxiliary equipment included in the calculation, with the type of machine and the selected cooling system, etc.

4.1.1.2 Cost allocation

Investment costs are a fixed cost that include the purchase price, building infrastructure costs, installation and insurance.

The share of the investment cost as a part of the overall cost is determined partly by the selection of the compressed air quality level and partly by the depreciation period and the applicable interest rate.

The share of energy costs is determined by annual operating time, the degree of load/unload utilization and the unit energy cost.

Additional investments, for example, equipment for energy recovery, offer a direct payoff in the form of reduced operating and maintenance costs.

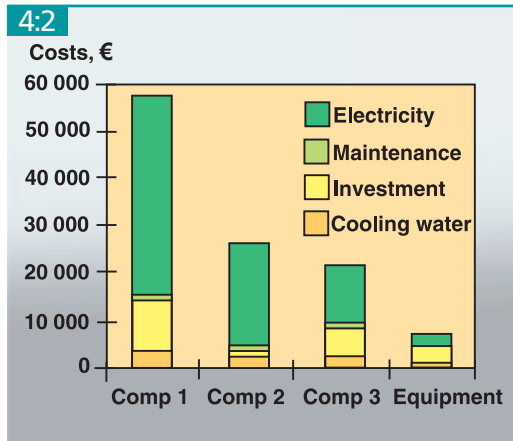

This chart illustrates how costs may be divided between 3 compressors and their auxiliary equipment. The large differences may be due to how the machines are valued, to the individual capital value of the equipment, to the selected level of safety that can affect the maintenance costs, etc.

4.2 OPPORTUNITIES FOR SAVING

4.2.1 Power requirement

When making calculations, it is important to apply the overall power requirement concept. All energy consumers that belong to a compressor installation should be accounted for: for example, inlet filters, fans and pumps, dryers and separators.

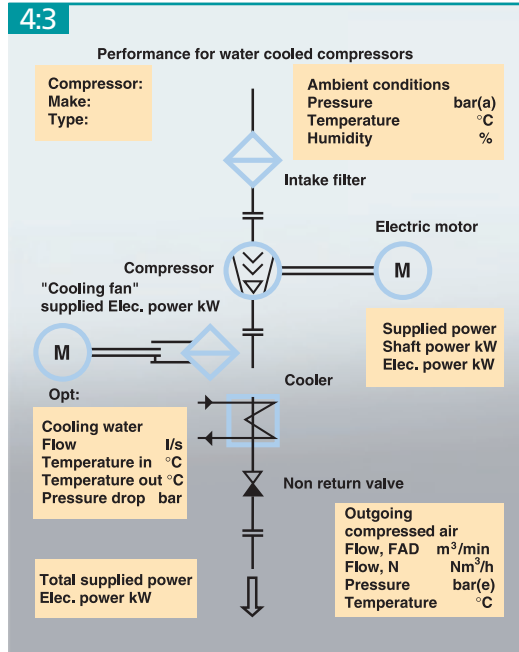

A simple but useful model that can be used to give a true picture of a compressor's electrical energy requirement.

For comparisons between different investment alternatives, the use of comparable values is particularly important. Therefore, the values must be stated in accordance with internationally recognized standards and regulations, for example, as per ISO 1217 Ed.4 -2009.

4.2.2 Working pressure

The working pressure directly affects the power requirement. Higher pressure signifies higher energy consumption: on average 8% more power for 1 bar higher pressure. Increasing the working pressure to compensate for a pressure drop always results in impaired operating economy. Despite this adverse economic effect, increasing compressor pressure is a commonly-used method for overcoming pressure drops caused by an underdimensioned pipe system or clogged filters. In an installation fitted with several filters, especially if they have been operational for a long period of time without being replaced, the pressure drop can be significantly higher and therefore very costly if unattended for long periods of time.

In many installations, it is not possible to imple-

4:4

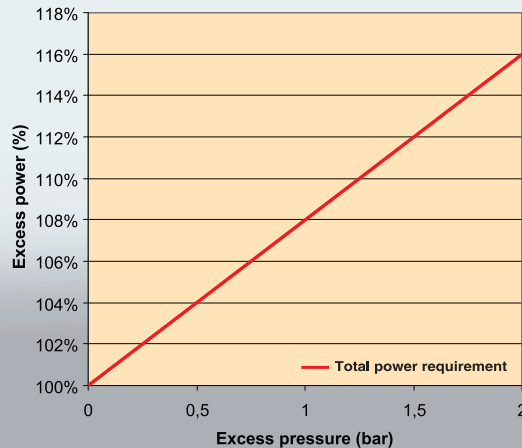

Excess power requirement as a result of over-pressurizing to compensate for pressure drops. For a 300 l/s compressor, raising the working pressure by 1 bar means 6 kW higher power consumption. At 4000 operating hours/year this represents 24,000 kWh/year or € 2,400/year.

ment large pressure reductions, but the use of modern regulation equipment allows the pressure to be realistically lowered by 0.5 bar. This represents a power savings of a few percent. This may seem to be insignificant, but considering that the total efficiency of the installation is increased by an equivalent degree, the value of this pressure reduction in terms of actual savings is more readily obvious.

4.2.3 Air consumption

By analyzing routines and the use of compressed air, solutions to provide a more balanced load

on the compressed air system can be found. The need for increased air flow production can thereby be avoided to reduce operating costs.

Unprofitable consumption, which usually is a consequence of leakage, worn equipment, processes that have not been properly configured or the incorrect use of compressed air, is best rectified by increasing general awareness. Dividing the compressed air system into sections that can be separated using shut-off valves can serve to reduce consumption during the night and over weekends. In most installations, there is some degree of leakage, which represents a pure loss and must therefore be minimized. Frequently

4:5

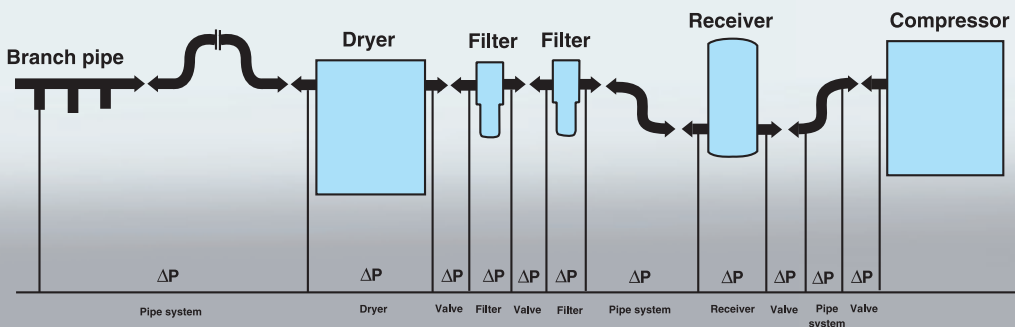



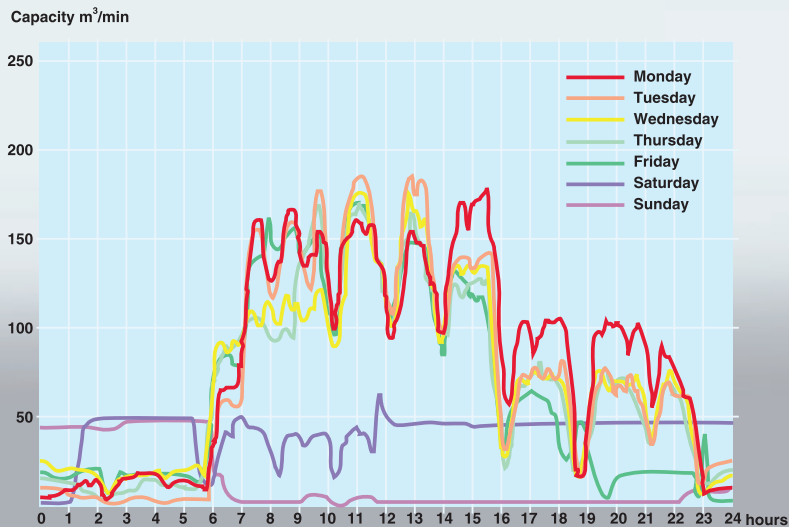

The pressure drop across different components in the network affects the requisite working pressure.

4:6



The diagram shows how air consumption can be varying during a week and 24 hours per day. Consumption is low during the night shift, is high during the day shift, and drops during breaks, but is constant during the weekends (leakage?).

4:7

Hole diameter		Output flow at 7 bar working pressure	Power requirement for the compressor
Size	mm	l/s	kW
	1	1.2	0.4
	3	11.1	4.0
	5	31	10.8
	10	124	43

The table illustrates the relation between leakage and power consumption for some small leakage holes at a system pressure of 7 bar(e).

leakage can amount to 10-15% of the produced compressed air flow. Leakage is also proportional to the working pressure, which is why one method of reducing leakage is to repair leaking equipment, and thereby lowering the working pressure, for example, at night.

Lowering the pressure by only 0.3 bar reduces leakage by 4%. If the leakage in an installation of 100 m³/min is 12% and the pressure is reduced by 0.3 bar, this represents a saving of approx. 3 kW.

4.2.4 Regulation method

Using a modern master control system, the compressor central plant can be run optimally for different operating situations while enhancing safety and availability.

Selecting the right regulation method encourages energy savings through lower system pressure and a better degree of utilization, which is optimized for each machine in the installation. At the same time availability increases, thereby reducing the risk of unplanned downtime. Also, central control allows programming for automatic pressure reduction in the entire system during operation at night and on weekends.

4:8

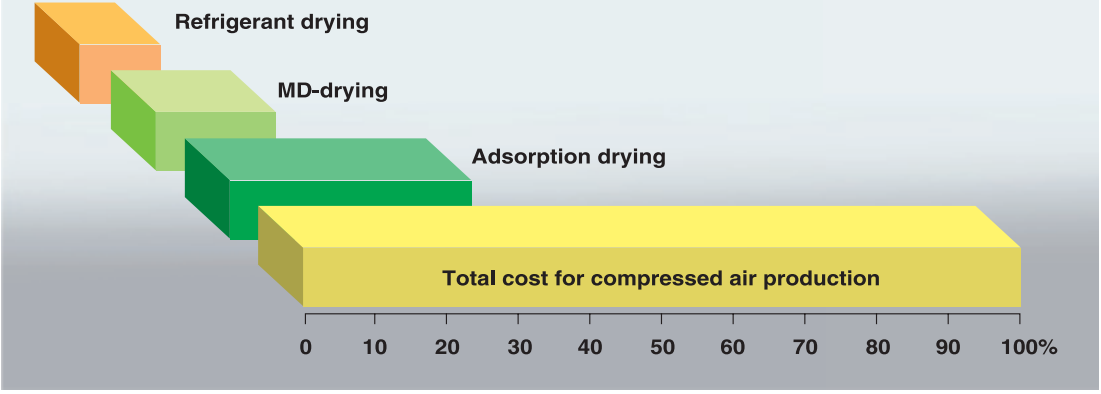

Cost comparison of different drying methods.

As compressed air consumption is seldom constant, the compressor installation should have a flexible design, using a combination of compressors with different capacities and speed-controlled motors. Compressors may run with speed-control and screw compressors are particularly suited for this, as their flow rate and their power consumption are virtually proportional to their speed.

4.2.5 Air quality

High quality compressed air reduces the need for maintenance, increases operating reliability of the pneumatic system, control system and instrumentation while limiting wear of the air-powered machines.

If the compressed air system is conceived for dry, oil-free compressed air from the start, the

4:9

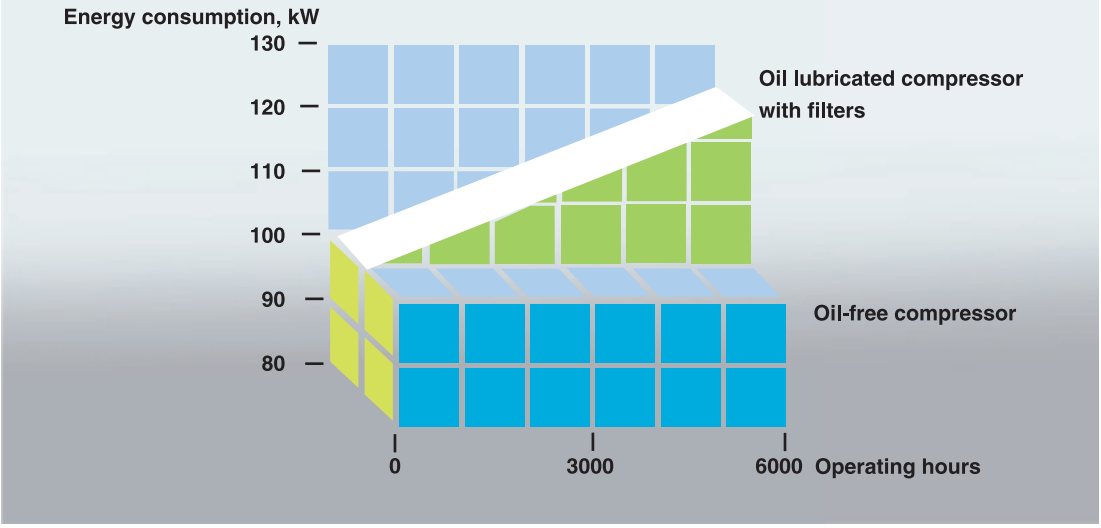

Oil-free compressors give constant compressed air quality at a fixed energy cost.

installation will be less expensive and simpler, as the pipe system does not need to be fitted with a water separator. When the air is dry, it is not necessary to discharge air into the atmosphere to remove condensation. Condensation drainage on the pipe system is also not required, which means lower costs for installation and maintenance. The most economic solution can be obtained by installing a central compressed air dryer. Decentralizing air treatment modules with several smaller units placed in the system is more expensive and makes the system harder to maintain.

Experience has shown that the reduced installation and maintenance costs for a system with dry compressed air will cover the investment cost of the drying equipment. Profitability is very high, even when drying equipment must be added to existing installations.

Oil-free compressors do not require an oil separator or cleaning equipment for condensation. Filters are not needed either and the cost for filter replacement is therefore eliminated. Consequently, there is no need to compensate for the pressure drop in the filter and the compressor's working pressure can be lowered. This contributes to improving the installation's economy even further.

4.2.6 Energy recovery

When using electricity, gas or oil for any form of heating within the production facilities or in the process, the possibility of fully or partly replacing this energy with recovered waste energy from the compressor installation should be investigated. The decisive factors are the energy cost in €/kWh, the degree of utilization and the amount of additional investment necessary. A well-planned investment in waste energy recovery often gives a payback time of only 1–3 years. Over 90% of the power supplied to the compressor can be recovered in the form of highly valuable heat. The temperature level of the recovered energy determines the possible application areas and, therefore, its value.

The highest degree of efficiency is generally obtained from water-cooled installations, when the compressor installation's hot cooling water outlet can be connected directly to a continuous heating demand, for example the existing heating boiler's return circuit. Recovered waste energy can then be effectively utilized year round. Different compressor designs give different prerequisites. In some situations requiring a large and peaking heat flow, long heat transport distances to the point of utilization, or a requirement that varies during the year, it may be interesting to look at the possibilities of selling the recovered energy in the form of heat or cooling or electricity, etc.

4:10

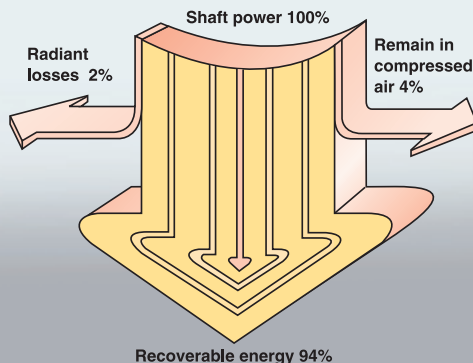

Recovered energy kWh/year:

$$W = [(K_1 \times Q_1) + (K_2 \times Q_2)] \times T_R$$

$$\text{Saving/year: } W \times e_p / \eta$$

$$\text{Saved oil m}^3/\text{year: } W / 6800 \times \eta$$

T_R = Time per year when there is a need of power recovery (hours/year)

K_1 = Part of T_R with loaded compressor

K_2 = Part of T_R with off-loaded compressor

Q_1 = Available power in coolant with loaded compressor (kW)

Q_2 = Available power in coolant with off-loaded compressor (kW)

e_p = Energy price

η = Normal heat source's efficiency.

At the same time as the compressor produces compressed air, it also converts the supplied energy into heat, which is transferred to the coolant, air or water. Only a small part is contained in the compressed air and is emitted as heat radiation from the machine and piping.

4:11

Different forms of maintenance

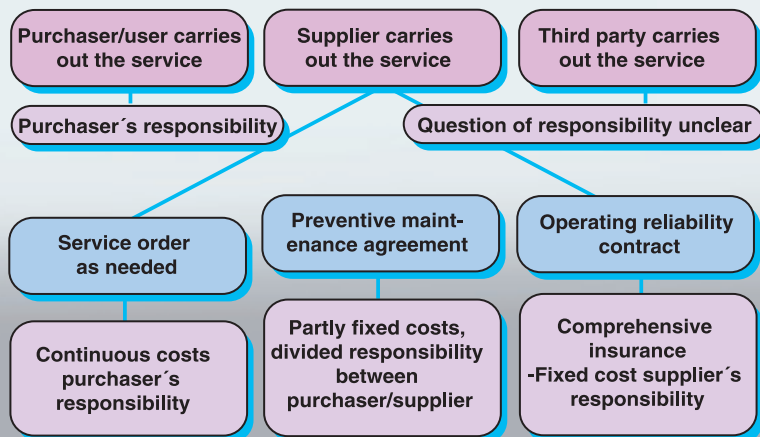

The highest possible degree of utilization reduces the cost of service and maintenance, expressed in €/operating hour. It is realistic to plan for 100% utilization and at least 98% availability.

4.2.7 Maintenance

As with all equipment, a compressor installation requires some form of maintenance. However, maintenance costs are low in relation to other costs and can be reduced further through careful planning measures. The choice of the maintenance level is determined by the required reliability and performance of the compressed air installation.

Maintenance makes up the smallest part of the installation's total cost of ownership. It depends on how the installation has been planned in general and the particular choice of compressor and auxiliary equipment.

Costs can be reduced by combining condition monitoring with other functions when using equipment for fully automatic operations, and monitoring of the compressor central plant. The total budget for maintenance is affected by:

- Type of compressors
- Auxiliary equipment (dryers, filters, control and regulation equipment)
- Operating cycle load/unload
- Installation conditions
- Media quality
- Maintenance planning
- Choice of safety level
- Energy recovery/cooling system
- Degree of utilization

The annual maintenance cost is usually between 5–10% of the machine's investment value.

4.2.7.1 Maintenance planning

Well-planned compressor maintenance allows costs to be anticipated and the service life of the machine and auxiliary equipment to be extended as a result. Costs for repairing small faults is also decreased and downtime is shortened.

By utilizing advanced electronics to a greater degree, machines are equipped with instruments for diagnostic examination. This means that component parts can be utilized optimally and replacement takes place only when truly needed. The need for reconditioning components can be discovered at an early stage before damage is significant, thereby avoiding subsequent damage and unnecessary downtime.

By utilizing the compressor supplier's after-market services, its staff and original spare parts, the machine can be expected to maintain a high technical operational standard, while offering the possibility of introducing modifications based on recent experiences during the machine's service life. The assessment of the maintenance requirement is made by specially-trained technicians, who also conduct training for in-house first-line maintenance staff. In-house skilled staff should preferably be used to perform daily inspections, as local ears and eyes can hear and see things that remote monitoring equipment cannot.

4.2.7.2 Auxiliary equipment

It is easy to expand an installation by adding numerous pieces of auxiliary equipment, for example, to increase the air quality or to monitor the system. However, even auxiliary equipment needs service and incurs maintenance costs (e.g. filter replacement, drying agent replacement, adaptation to other equipment and staff training.)

In addition, secondary maintenance costs exist, for example, for the distribution network and production machines, which are affected by the quality of the compressed air, and include deposit costs for oil and filter cartridges. All of these costs must be evaluated in the cost of ownership calculation that forms the basis for any new compressor investment.

4.3 LIFE CYCLE COST

4.3.1 General

A common way to describe and analyze the investment in a product, a material or a particular service in a systematic, yet simplified fashion, is by using a life cycle cost (LCC) analysis. This analysis examines all of the stages in the life cycle of the operating product or the service. This includes everything from the selection of raw material to final waste removal/recycling.

The analysis is often used as a comparison tool between different investment options, for example, for products or systems with an equivalent

4:12

Example of a compressor calculation

Input data						
Price of electricity	€/kWh	0,10				
Calculated interest	%	12				
Deprecation period	years	10				
Operating time	hours/year	6,000				
Annual consumption		Comp 1	Comp 2	Comp 3	Dryers	TOTAL
Electricity	MWh/year	1,200	550	400	133	2,294
Water (circulation system)	m ³ /year	—	—	—	—	—
Divided operating costs						
Electricity	€/year	120,000	55,500	40,000	13,300	229,400
Water	€/year	1,000	500	300	0	1,650
Annual costs without energy recovery	€/year	152,500	75,000	51,000	22,500	301,000
Operating costs	€/year	121,000	56,000	40,300	13,300	230,600
Capital expenditure	€/year	25,000	15,000	8,000	7,000	55,000
Service & Maintenance	€/year	6,500	4,000	2,700	2,200	15,400
Air production - total	Mm³/year	12,660	5,770	3,640	-	22,070
Energy recovery						
Energy cost (for the alternative use)	€/kWh	0,08	0,08	0,08	-	-
Recovery period	months/year	10	10	8	-	-
Degree of recovery	%	93	93	93	-	-
Quantity of recovered energy	MWh/year	874	402	234	-	1510
Annual cost with energy recovery	€/year	82,500	43,000	32,000	22,500	180,000
Saving with energy recovery	€/year	70,000	32,000	19,000	-	121,000
Specific cost without energy recovery	€/m³	0,0120	0,0130	0,0140	0,0012	0,0136
Specific cost with energy recovery	€/m³	0,0065	0,0075	0,0088	-	0,0082

Note: values rounded off;
electricity cost estimate 0,1 €/kWh;

function. The LCC result is often used to provide guidance in issues concerning specific processes or specific product design elements. LCC analyses can also be used by companies in communication with subcontractors, with customers or with the authorities to describe their system characteristics.

The results from an LCC analysis can serve as a basis for making decisions that will minimize a product or a service's operational impact on the environment. However, LCC analysis does not offer answers to all possible questions, which is why other aspects such as quality and available technology must be examined to provide relevant background material.

4.3.2 LCC calculation

LCC calculations are used more and more as a tool to evaluate various investment options. Included in the LCC calculation are combined costs due to the product operating over a specific period, which include the capital expenditure, the operating cost and the maintenance service cost.

The LCC calculation is often implemented based on a planned installation or a working installation. This serves as the basis for defining requirements for a new installation. It should, however, be pointed out that an LCC calculation is often only a qualified estimate of future costs and is somewhat limited due to it being based on current knowledge of the condition of equipment condition and impacted by future evolutions in energy prices.

Nor does this calculation account for any "soft" values that can be just as important, such as production safety and its subsequent costs.

4:13

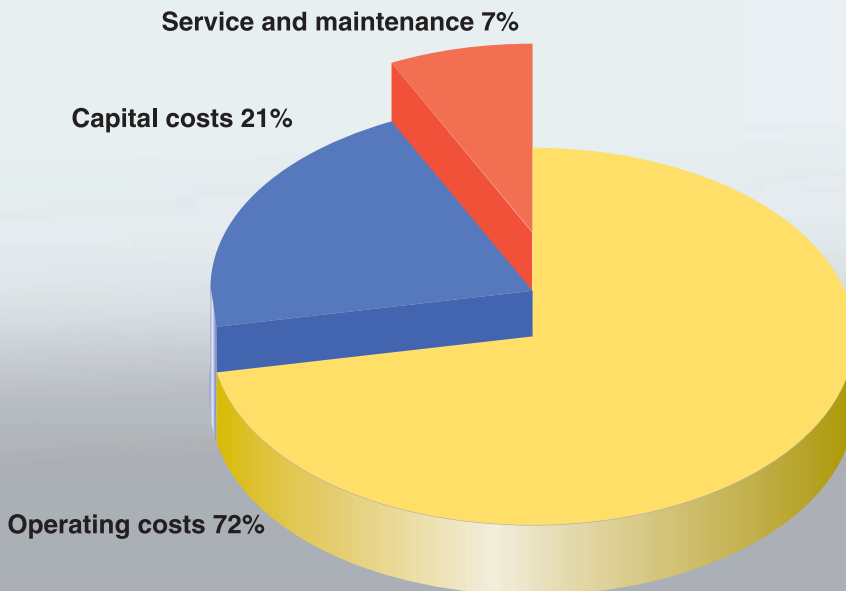

Compressed air cost contributors without energy recovery.

4:14

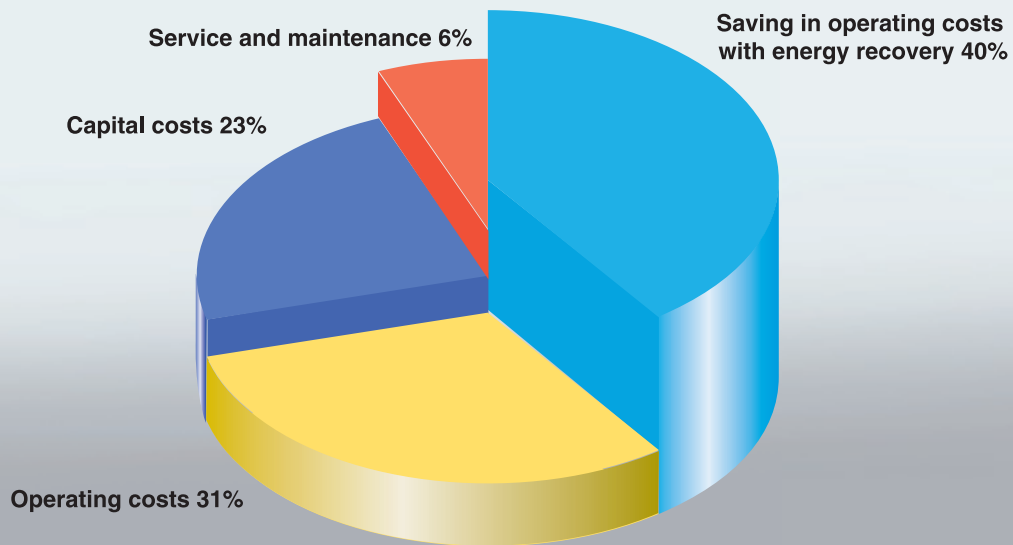

Compressed air cost contributors with energy recovery.

Making an LCC calculation requires knowledge and preferably experience with other compressed air installations. Ideally, it should be made jointly by the purchaser and the salesman. Critical issues include how different investment options affect factors like production quality, production safety, subsequent investment requirements, production machine and the distribution network maintenance, environmental impact, the quality of the final product, and risks for downtime and for rejections. An expression that must not be forgotten in this context is LCP, Life Cycle Profit. This represents the earnings that can be gained through energy recovery and reduced rejections, to name but a few possibilities.

When assessing service and maintenance costs, the equipment's expected condition at the end of the calculation period must also be taken into account (i.e. whether it should be seen as fully

used or be restored to its original condition). Furthermore, the calculation model must be adapted to the type of compressor involved. The example in chapter 5 can serve as a model for the economic assessment of a compressor installation, with or without energy recovery.

5

CALCULATION EXAMPLE

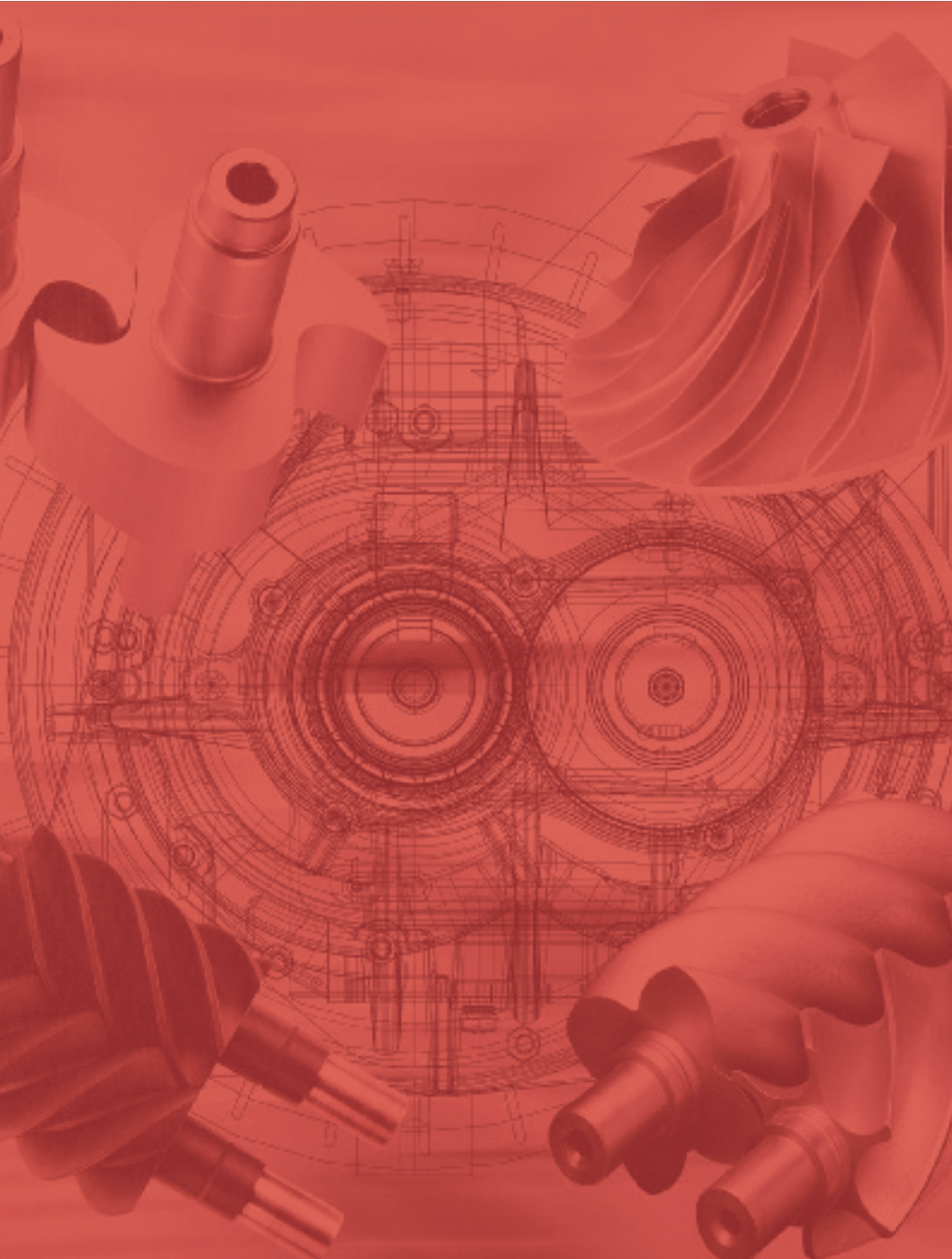

5.1 EXAMPLE OF DIMENSIONING COMPRESSED AIR INSTALLATIONS

The following paragraphs contain calculations for dimensioning a typical compressed air installation. Their purpose is to show how some of the formulas and reference data from previous chapters are used. The example is based on a given compressed air requirement and the resulting dimensioned data are based on components that have been selected for this particular compressed air installation.

Following the paragraph dealing with a typical case are a few additional paragraphs that illustrate how special cases can be handled: high altitude, intermittent output, energy recovery and calculating pressure drop in the piping.

5.2 INPUT DATA

The quantitative compressed air requirements and the local ambient conditions must be established before starting any dimensioning. In addition to this quantitative requirement, a qualitative selection involving whether the compressor should be oil-lubricated or oil-free and whether the equipment should be water-cooled or air-cooled must be made.

5.2.1 Compressed Air Requirement

Assume that the installation contains three compressed air consumers with the following data:

Consumer	Air Flow	Pressure	Dew Point
1	12 Nm ³ /min	6 bar(e)	+6°C
2	67 l/s (FAD)	7 bar(a)	+6°C
3	95 l/s (FAD)	4 bar(e)	+6°C

5.2.2 Ambient conditions for dimensioning

Normal ambient temperature: 20°C

Maximum ambient temperature: 30°C

Ambient pressure: 1 bar(a)

Humidity: 60%

5.2.3 Additional specifications

Air-cooled equipment only.

Compressed air quality from oil-lubricated compressors.

5.3 COMPONENT SELECTION

Recalculate all input data from the requirement table in 5.2.1, to ensure that it is normalized with regard to measurement units before dimensioning the different components.

Flow conversion:

In general, the unit l/s is used to define compressor capacity, which is why consumer 1, given in Nm³/min, must be recalculated in l/s.

$$12 \text{ Nm}^3/\text{min} = 12 \times 1000/60 = 200 \text{ NI/s.}$$

Inserting the current input data in the formula gives:

$$q_{FAD} = \frac{q_N \times (273 + T_{FAD}) \times 1,013}{273 \times p_{FAD}} = \frac{200 \times (273 + 30) \times 1,013}{273 \times 1,00} \approx 225 \text{ l/s}$$

q_{FAD} = Free Air Delivery (l/s)

q_N = Normal volume rate of flow (NI/s)

T_{FAD} = maximum inlet temperature (30°C)

T_N = Normal reference temperature (0°C)

p_{FAD} = standard inlet pressure (1.00 bar(a))

p_N = Normal reference pressure (1.013 bar(a))

Pressure conversion:

The unit generally used to define pressure for compressed air components is effective pressure (also called gauge pressure), stated in bar(e).

Consumer 2 is stated in absolute pressure, 7 bar(a). The ambient pressure is subtracted from 7 bar to yield the effective pressure. As the ambient pressure in this case is 1 bar(a) the pressure for consumer 2 can be written as (7-1) bar(e) = 6 bar(e).

With the above recalculations, the table with uniform requirement data becomes:

Consumer	Air Flow	Pressure	Dew Point
1	225 l/s (FAD)	6 bar(e)	+5°C
2	67 l/s (FAD)	6 bar(e)	+5°C
3	95 l/s (FAD)	4 bar(e)	+5°C

5.3.1 Dimensioning the compressor

The total air consumption is the sum of the three consumers 225 + 67 + 95 = 387 l/s. Taking into account possible changes in the planned air consumption data, and later incremental expansion of compressed air needs, a safety margin of approx. 10-20% should be added. This gives a dimensioned flow rate of 387 x 1.15 ≈ 450 l/s (including the 15% safety margin).

The maximum required pressure for all consumers is 6 bar(e). A reducing valve should be fitted to the consumer number 3 with the requirement of 4 bar(e).

Assuming that the combined pressure drop in the dryer, filter and piping does not exceed 1.5 bar, a compressor with a maximum working pressure capability of no less than $6 + 1.5 = 7.5$ bar(e) is suitable for this case.

5.3.2 Final compressor selection

A compressor with the following specifications is selected:

Oil-injected screw compressor type

Maximum compressor outlet pressure = 7.5 bar(e)

FAD at 7 bar(e) = 450 l/s

This requirement is met by a compressor with installed motor shaft power = 162 kW.

The compressed air temperature out of the compressor aftercooler = ambient temperature +10°C.

Furthermore, the selected compressor has loading/unloading regulation with a maximum cycle frequency of 30 seconds. Using loading/unloading regulation, the selected compressor has a pressure fluctuation between 7.0 and 7.5 bar(e).

5.3.3 Dimensioning the air receiver volume

q_c = compressor capacity = 450 l/s

p_i = compressor inlet pressure = 1 bar(a)

T_1 = maximum inlet temperature = 30°C = 273 + 30 = 303 K

f_{max} = maximum cycle frequency = 1 cycle/30 seconds

$(p_u - p_l)$ = pressure difference between Loaded and Unloaded compressor = 0.5 bar

T_0 = compressed air temperature out of the selected compressor is 10°C higher than the ambient temperature; therefore the maximum temperature in the air receiver will be = 273 + 40 = 313 K

Compressor with loading/unloading regulation gives the following formula for the air receiver volume:

$$V = \frac{0.25 \times q_c \times T_0}{f_{max} \times (p_u - p_l) \times T_1} = \frac{0.25 \times 450 \times 313}{1/30 \times 0.5 \times 303} = 6.895 \text{ liter}$$

This is the minimum recommended air receiver volume.

The next larger standard size is usually selected.

5.3.4 Dimensioning the dryer

The required dew point in this example is +5°C, therefore a refrigerant dryer is the most suitable choice of dryer. When selecting the dryer size a number of factors must be taken into consideration and the refrigerant dryer capacity should be corrected using appropriate correction factors. These correction factors are unique to each refrigerant dryer model. In the case below, the correction factors applicable for Atlas Copco refrigerant dryers are used, and they are stated on the Atlas Copco product data sheet. The correction factors are:

1. Refrigerant dryer inlet temperature and pressure dew point.

Because the compressed air temperature out of the compressor is 10°C higher than the ambient temperature, the refrigerant dryer inlet temperature will be maximum 30 + 10 = 40°C. In addition, the desired pressure dew point is +5°C.

The appropriate correction factor 0.95 is obtained from the Atlas Copco data sheet.

2. Working pressure

The actual working pressure is approx. 7 bar, which represents a correction factor of 1.0.

3. Ambient temperature

For a maximum ambient temperature of 30°C a correction value of 0.95 is obtained.

Consequently, the refrigerant dryer should be able to handle the compressor's full capacity multiplied by the correction factors above.

$$450 \times 0.95 \times 1.0 \times 0.95 = 406 \text{ l/s.}$$

5.3.5 Summary for continued calculation

An air-cooled refrigerant dryer with the followed data is selected:

Capacity at 7 bar(e) = 450 l/s

Total power consumption = 5.1 kW

Emitted heat flow to surroundings = 14.1 kW

Pressure drop across the dryer = 0.09 bar

5.3.6 Checking calculations

When all components for the compressor installation have been selected, it must be ensured that the total pressure drop is not too great. This is done by adding up all of the pressure drops for the components and pipes. It may be appropriate to draw a schematic diagram of the compressed air installation as shown in Figure 5:1.

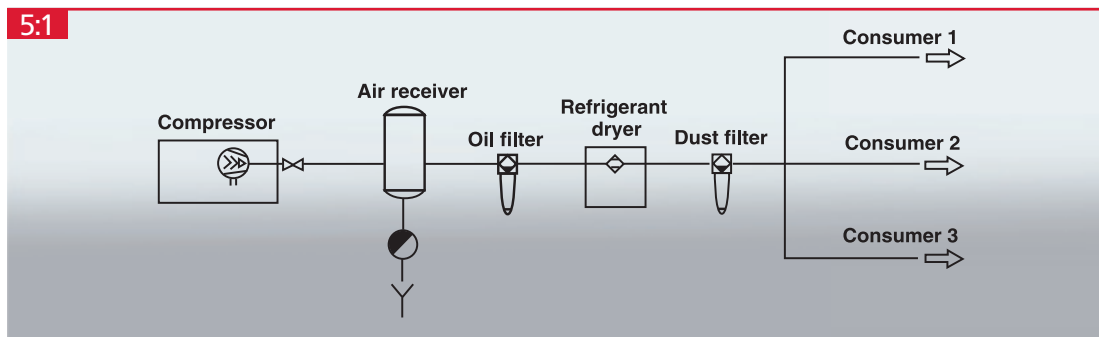

The pressure drop for the components is obtained from the component suppliers, while the pressure drop in the pipe system should not exceed 0.1 bar.

The total pressure drop can now be calculated:

Component	Pressure drop (bar)
Oil filter (pressure drop when filter is new)	0.08
Refrigerant dryer	0.09
Dust filter (pressure drop when filter is new)	0.08
Pipe system in compressor central plant	0.05
Pipes from compressor central plant to consumption points	0.1
Total pressure drop:	0.4

The maximum unloaded pressure of 7.5 bar(e) and load pressure of 7.0 bar(e) for the selected compressor gives a lowest pressure at the consumers of $7.0 - 0.4 = 6.6$ bar(e). Add to this the additional pressure drop increase across the filter that occurs over time. This pressure drop increase is unique for each filter type and can be obtained from the Atlas Copco product data sheet.

5.4 ADDITIONAL DIMENSIONING WORK

5.4.1 Condensation quantity calculation

Because an oil-lubricated compressor has been chosen, the water condensation separated in the compressor and refrigerant dryer will contain small amounts of oil. The oil must be separated before the water is released into the sewer, which can be done using oil separator. Information on how much water is condensed is needed in order to properly dimension the oil separator.

The total amount of water in the air flow taken in by the compressor is obtained from the relation:
 $f_1 = \text{relative humidity} \times \text{the amount of water (g/liter) that the air can carry at the maximum ambient temperature } 30^\circ\text{C} \times \text{air flow.}$

$$f_1 = 0.6 \times 0.030078 \times 445 \approx 8.0 \text{ g/s}$$

$f_2 =$ amount of air remaining in the compressed air after drying (saturated condition at $+6^\circ\text{C}$).

$$f_2 = \frac{1 \times 0.007246 \times 445}{8} \approx 0.4 \text{ g/s}$$

The total condensation flow from the installation f_3 then becomes:

$$f_3 = f_1 - f_2 = 8.0 - 0.4 = 7.6 \text{ g/s} \approx 27.4 \text{ kg/hour}$$

This figure assumes continuous load for one hour.

With the help of the calculated condensation flow, the right oil separator can now be chosen.

5.4.2 Ventilation requirement in the compressor room

The principle that the heat released into the room air will be removed with the ventilation air is used to determine the ventilation requirement in the compressor room.

For this calculation the following relationship is used:

$$P = m \times c_p \times \Delta T$$

$P =$ the total heat flow (kW)

$m =$ mass flow (kg/s)

$c_p =$ specific heat (J/kg x K)

$\Delta T =$ temperature difference (K)

The formula for the ventilation mass flow can be written as:

$$m = \frac{P}{c_p \times \Delta T}$$

where:

ΔT = the maximum allowed ventilation air temperature increase (say, 10 K)

c_p = 1.006 kJ/kg x K (at 1 bar and 20°C)

P = (roughly 94% of the supplied shaft power to the compressor + the difference between the supplied total power to the compressor package and the supplied shaft power to the compressor + the stated heat flow from the refrigerant dryer) = $(0.94 \times 162) + (175 - 162) + 14.1 \approx 180$ kW

Thus the ventilation air mass flow is:

$$m = \frac{P}{c_p \times \Delta T} = \frac{180}{1.006 \times 10} = 17.9 \text{ kg/s}$$

At an air density of 1.2 kg/m³ this mass flow represents $17.9/1.2 \approx 15$ m³/s.

5.5 SPECIAL CASE: HIGH ALTITUDE

Question:

Imagine that the same compressed air requirement as described in the previous example is specified, but at an altitude of 2,500 meters above sea level and with a maximum ambient temperature of 35°C. What compressor capacity (expressed as free air delivery) is required in this case?

Answer: Air becomes thinner at higher altitudes. This is a fact that must be taken into consideration when dimensioning compressed air equipment to fulfill a compressed air requirement specified for Normal conditions, in Nm³/min. For cases in which the consumer flow requirement is stated in free air delivery (FAD), no recalculation is necessary.

As consumer 1 in the example above is specified in Nm³/min at 1.013 bar(a) and 0°C, the requisite FAD flow for this consumer must be recalculated for the condition 35°C at 2,500 m altitude. Using a look-up table, the ambient pressure at 2,500 meters above sea level is 0.74 bar. The flow for consumer 1, recalculated to NI/s (12 Nm³/min = 200 NI/s), is then entered in the formula below:

$$q_{FAD} = q_N \times \frac{T_{FAD}}{T_N} \times \frac{p_N}{p_{FAD}} = 200 \times \frac{(273 + 35)}{273} \times \frac{1.013}{0.74} \approx 309 \text{ l/s}$$

The total compressed air capacity demanded is then $309 + 67 + 95 = 471$ l/s (FAD).

5.6 SPECIAL CASE: INTERMITTENT OUTPUT

Question:

Imagine that in this sample calculation, there is an extra requirement from consumer 1 of a further 200 l/s for 40 seconds of every hour. During this intermittent phase, the pressure in the system is allowed to drop to 5.5 bar(e). How large should the volume of the receiver be to meet this extra requirement?

Answer: During a short period, more compressed air can be delivered than what the compressors jointly can manage by using the stored compressed air in an air receiver. However, in order to fill this air receiver between the intermittent periods in which extra air is needed, the compressor must feature a specific over-capacity. The following relation applies:

$$V = \frac{q \times t}{P_1 - P_2}$$

q = air flow during the emptying phase = 200 l/s

t = length of the emptying phase = 40 seconds

$p_1 - p_2$ = permitted pressure drop during the emptying phase = normal system pressure - minimum accepted pressure at emptying phase = 6.42 - 5.5 = 0.92 bar

Inserted in the above formula for the required air receiver volume:

$$V = \frac{q \times t}{P_1 - P_2} = \frac{200 \times 40}{0.92} \approx 8700 \text{ l}$$

In addition, the compressor must have a specific over-capacity, so that it can fill the air receiver after the emptying phase. If the selected compressor has an over-capacity of 5 l/s = 18,000 liters/hour, the above calculated receiver volume would be filled within half an hour. As the air receiver will be emptied only once every hour, this compressor over-capacity is sufficient.

5.7 SPECIAL CASE: WATERBORNE ENERGY RECOVERY

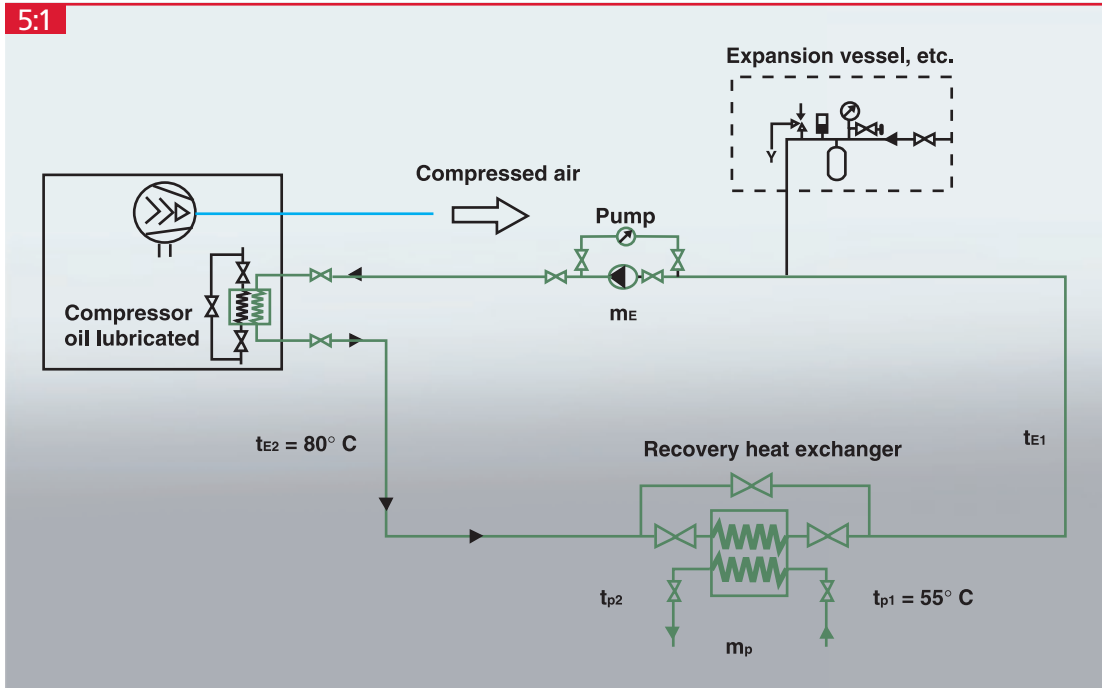

Question:

How do we build a waterborne energy recovery circuit for the compressor in the example? The application water to be heated is a warm water return line (boiler return) with a return temperature of 55°C . Calculate the flow required for the energy recovery circuit and the power that can be recovered by the application. Also calculate the flow and outgoing temperature for the boiler return.

Answer: Start by drawing the energy recovery circuit and name the different powers, flows and temperatures. Now perform the calculation below.

P_E = power transferred from the compressor to the energy recovery circuit (kW)

P_A = power transferred from the energy recovery circuit to the application (kW)

m_E = water flow in the energy recovery circuit (l/s)

m_A = water flow in the boiler return (l/s)

t_{E1} = water temperature before the compressor ($^\circ\text{C}$)

t_{E2} = water temperature after the compressor ($^\circ\text{C}$)

t_{A1} = ingoing temperature on the boiler return ($^\circ\text{C}$)

t_{A2} = outgoing temperature on the boiler return ($^\circ\text{C}$)

5.7.1 Assumption

The following assumptions have been made:

The water temperature out of the compressor that is suitable for energy recovery can be obtained from the compressor supplier. It is assumed to be $t_{E2} = 80^\circ\text{C}$.

Assumption for the water circuit through the energy recovery heat exchanger:

$$t_{E1} = t_{A1} + 5^{\circ}\text{C} = 55^{\circ}\text{C} + 5^{\circ}\text{C} = 60^{\circ}\text{C}$$

$$t_{A2} = t_{E2} - 5^{\circ}\text{C} = 80^{\circ}\text{C} - 5^{\circ}\text{C} = 75^{\circ}\text{C}$$

In addition, it is assumed that the pipe system and heat exchanger have no heat exchange with the surroundings.

5.7.2 Calculation of the water flow in the energy recovery circuit

$$P = m \times c_p \times \Delta T$$

$$\Delta T = \text{temperature increase across the compressor} = t_{E2} - t_{E1} = 80^{\circ}\text{C} - 60^{\circ}\text{C} = 20^{\circ}\text{C}$$

$$c_p = \text{specific heat capacity for water} = 4.185 \text{ kJ/kg} \times \text{K}$$

$$m = \text{mass flow in the energy recovery circuit} = m_E$$

$$P = 70\% \text{ of the supplied shaft power} = P_E = 0.70 \times 162 = 113 \text{ kW}$$

This is the maximum possible power to recover from the selected compressor. The formula can be written as:

$$m_E = \frac{P_E}{c_p \times \Delta T} = \frac{113}{4.185 \times 20} = 1.35 \text{ kg/s} = 1.35 \text{ l/s}$$

5.7.3 Energy balance across the recovery heat exchanger

For the recovery heat exchanger the following applies:

$$P_E = m_E \times c_p \times (t_{E2} - t_{E1})$$

$$P_A = m_A \times c_p \times (t_{A2} - t_{A1})$$

However, as it has been presumed that no heat exchange takes place with the surroundings, the power transferred to the energy recovery circuit from the compressor will be equal to the power transferred in the recovery heat exchanger, i.e. $P_A = P_E = 113 \text{ kW}$.

The formula can be written as:

$$m_A = \frac{P_A}{(t_{A2} - t_{A1}) \times c_p} = \frac{113}{(75 - 55) \times 4.185} \approx 1.35 \text{ kg/s} = 1.35 \text{ l/s}$$

5.7.4 Summary

The calculation illustrates that the power which can be recovered is 113 kW. This requires a water flow in the energy recovery circuit of 1.35 l/s. An appropriate flow for the boiler return is also 1.35 l/s with an increase of the boiler feed temperature by 20°C.

5.8 SPECIAL CASE: PRESSURE DROP IN THE PIPING

Question:

A 23-meter pipe with an inner diameter of 80 mm shall lead a compressed air flow of $q_c = 140$ l/s. The pipe is routed with 8 elbows that all have a bending radius equal to that of the pipe inner diameter. What will be the pressure drop across the pipe be if the initial pressure is 8 bar (a)?

Answer: First, determine the equivalent pipe length for the 8 elbows. The equivalent pipe length of 1.3 meter per elbow can be determined from Figure 3:36. The total pipe length is thus $8 \times 1.3 + 23 = 33.4$ meters. The following formula is used to calculate the pressure drop:

$$\Delta p = 450 \frac{q_c^{1.85} \times l}{d^5 \times p} = 450 \frac{140^{1.85} \times 33.4}{80^5 \times 8} \approx 0.0054 \text{ bar}$$

Accordingly, the total pressure drop across the pipe will be 0.0054 bar, which is very low.

6 APPENDICES

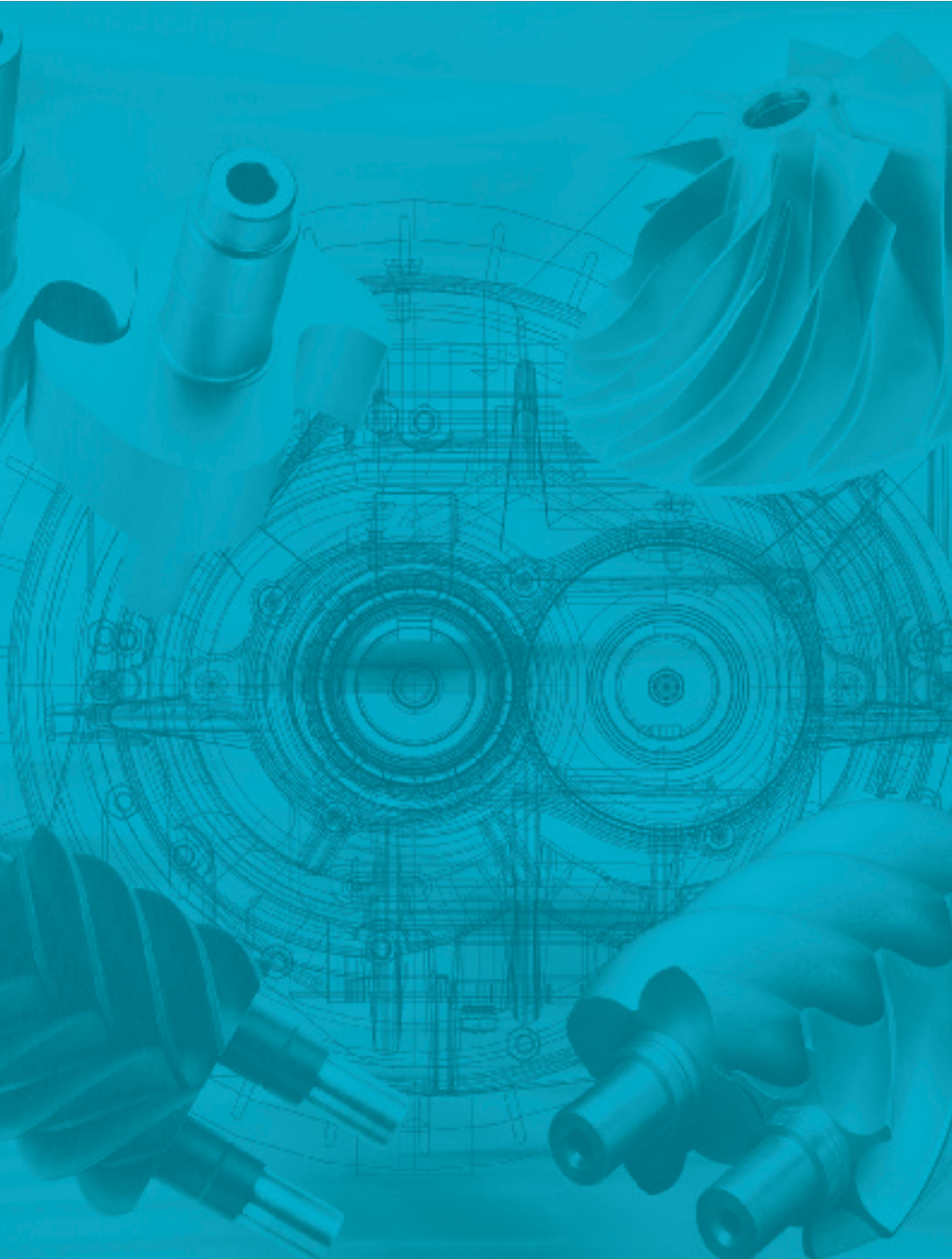

6.1 THE SI SYSTEM

Any physical quantity is the product of a numerical value and a unit. Since 1964, the International System of Units (SI system) has gradually been adopted worldwide, with the exception of Liberia, Myanmar and the United States. Basic information can be found in standard ISO 31, which is under revision and will be superseded by ISO/IEC 80000: *Quantities and Units*.

Units are divided into four different classes:

- Base units
- Supplementary units
- Derived units
- Additional units

Base units, supplementary units and derived units are called SI units. The additional units are not SI units, although they are accepted for use with SI units. Base units are any of the estab-

lished, independent units in which all other units can be expressed.

There are 7 base units in the SI system:

Length	meter	m
Mass	kilogram	kg
Time	second	s
Electrical current	ampere	A
Temperature	kelvin	K
Luminous intensity	candela	cd
Amount of substance	mole	mol

Derived units are formed as a power or product of powers of one or more base units and/or supplementary units according to the physical laws for the relationship between these different units.

Additional units:

A limited number of units outside the SI system cannot be eliminated for different reasons, and continue to be used along with the SI as additional units.

The 15 most important derived units below have been given generic names:

Quantity	Unit	Symbol	Expressed in other SI units
frequency	hertz	Hz	s^{-1}
force	newton	N	$kg \times m \times s^{-2}$
pressure / mechanical stress	pascal	Pa	N / m^2
energy / work	joule	J	$N \times m$
power	watt	W	J / s
electric quantity / charge	coulomb	C	$A \times s$
electric voltage	volt	V	W / A
capacitance	farad	F	C / V
resistance	ohm	Ω	V / A
conductivity	siemens	S	A / V
magnetic flux	weber	Wb	$V \times s$
magnetic flux density	tesla	T	Wb / m^2
inductance	henry	H	Wb / A
luminous flux	lumen	lm	$Cd \times sr$
light	lux	lx	Lm / m^2
angle	radian	rad	m / m
solid angle	steradian	sr	m^2 / m^2

The following are common additional units for technical use:

Quantity	Unit	Symbol	Remark
volume	liter	l	1 l = 1 dm ³
time	minute	min	1 min = 60 s
time	hour	h	1 h = 60 min
mass	metric ton	t	1 t = 1.000 kg
pressure	bar	bar	1 bar = 10 ⁵ Pa
plane angle	degree	.°	1° = π/180 rad
plane angle	minute	′	1′ = 1°/60
plane angle	second	″	1″ = 1′/60

Prefixes may be added to a unit to produce a multiple of the original unit. All of these multiples are integer powers of ten, for example:













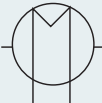









- *kilo*-denotes a multiple of thousand (10³)
- *milli*-denotes a multiple of one thousandth (10⁻³)

Fourteen such prefixes are listed in international recommendations (standards) as set out in the table below.

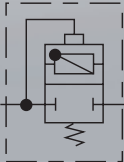
Power	Prefix Designation	Prefix Symbol	Example	Symbol
10 ¹²	tera	T	1 terajoule	1 TJ
10 ⁹	giga	G	1 gigahertz	1 GHz
10 ⁶	mega	M	1 megawatt	1 MW
10 ³	kilo	k	1 kilometer	1 km
10 ²	hecto	h	1 hectoliter	1 hl
10 ¹	deca	da	1 decalumen	1 dalm
10 ⁻¹	deci	d	1 decibel	1 dB
10 ⁻²	centi	c	1 centimeter	1 cm
10 ⁻³	milli	m	1 milligram	1 mg
10 ⁻⁶	micro	μ	1 micrometer	1 μm
10 ⁻⁹	nano	N	1 nanohenry	1 nH
10 ⁻¹²	pico	p	1 picofarad	1 pF
10 ⁻¹⁵	femto	f	1 femtometer	1 fm
10 ⁻¹⁸	atto	a	1 attosecond	1 as

For reference: www.bipm.org/en/si/

6.2 DRAWING SYMBOLS

	Air filter		Ejector
	Silencer		Water-cooled cooler
	Diffuser		Water separator
	Compensator		Condensation receiver
	Throttle valve		Direction of flow
	Screw compressor		Air-cooled cooler
	Non-return valve		Fan
	Stop valve		Expansion vessel
	Safety valve		Minimum pressure valve
	Manual valve		Thermostat valve
	Valve closing on failure of actuating energy		
	Valve opening on failure of actuating energy		
	Oil separator		

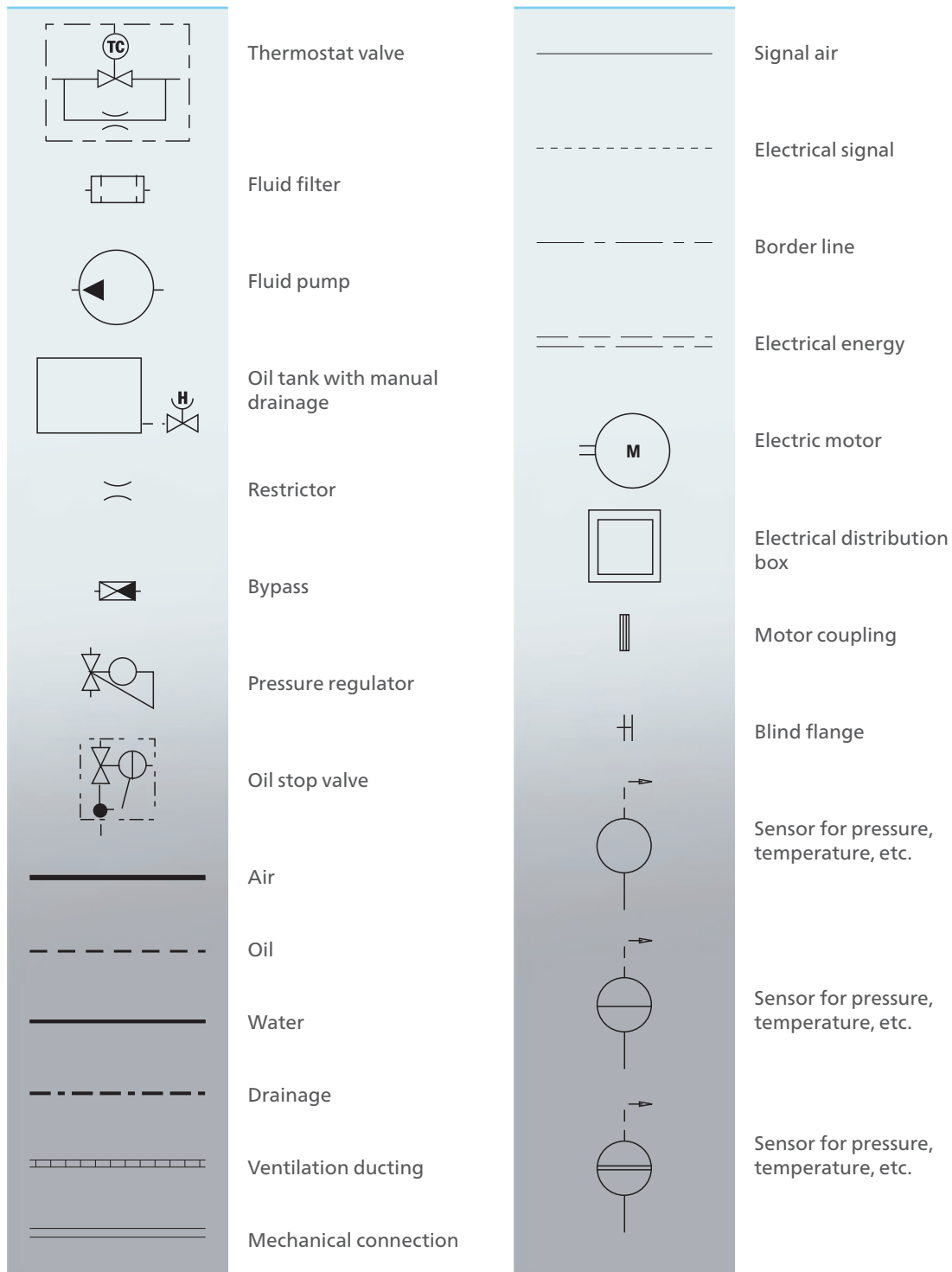

6.3 DIAGRAMS AND TABLES

Material	J/kg x K
air (atmospheric pressure)	1 004
aluminium	920
copper	390
oil	1 670-2 140
steel	460
water	4 185
zinc	385

Specific heat capacity for some materials.

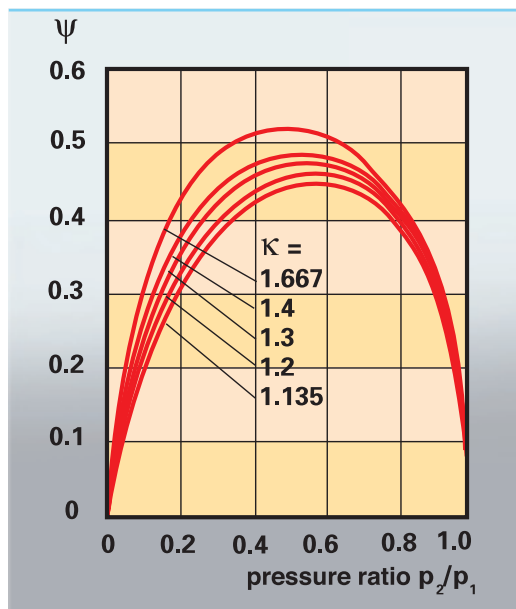

Flow coefficients as a function of the pressure relationship for different K-values.

boiling point	78.8	K
critical pressure (a)	97.66	bar
critical temperature	132.52	K
specific weight	1.225	kg/m ³
dynamic viscosity	17.89x10 ⁻⁶	Pa x s
freezing point	57-61	K
gas constant	287.1	J/(kg x K)
kinematic viscosity	14.61x10 ⁻⁵	m/s ²
molar mass	28.964	dimensionless
heat capacity at:		
constant pressure	1.004	kJ/(kg x K)
specific heat capacity ratio	1.40	dimensionless
speed of sound	340.29	m/s
thermal conductivity	0.025	W/(m x k)

Some physical properties of dry air at 15°C and 1,013 bar.

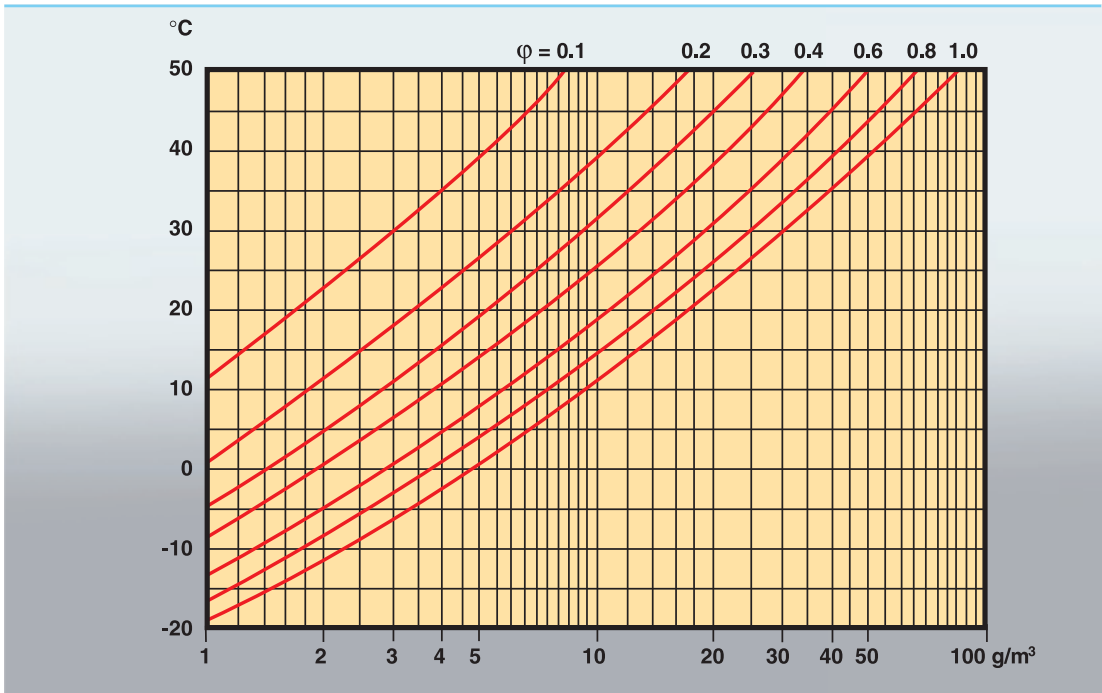

Water content in air at different relative vapor pressures (ϕ)

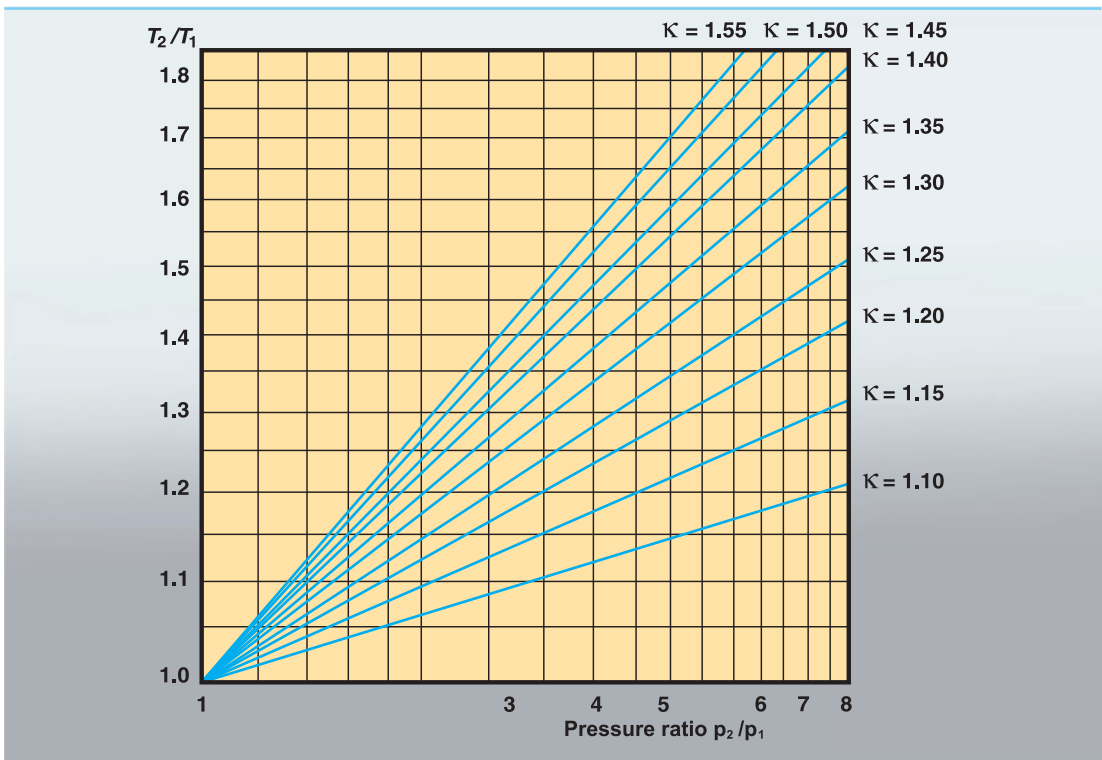

Diagram showing the temperature ratio T_2/T_1 for different gases having different K-values during isentropic compression.

t °C	Ps mbar	ρ_w g/m ³	t °C	Ps mbar	ρ_w g/m ³
-40	0.128	0.119	5	8.72	6.80
-38	0.161	0.146	6	9.35	7.26
-36	0.200	0.183	7	10.01	7.75
-34	0.249	0.225	8	10.72	8.27
-32	0.308	0.277	9	11.47	8.82
-30	0.380	0.339	10	12.27	9.40
-29	0.421	0.374	11	13.12	10.01
-28	0.467	0.413	12	14.02	10.66
-27	0.517	0.455	13	14.97	11.35
-26	0.572	0.502	14	15.98	12.07
-25	0.632	0.552	15	17.04	12.63
-24	0.689	0.608	16	18.17	13.63
-23	0.771	0.668	17	19.37	14.48
-22	0.850	0.734	18	20.63	15.37
-21	0.937	0.805	19	21.96	16.31
-20	1.03	0.884	20	23.37	17.30
-19	1.14	0.968	21	24.86	18.34
-18	1.25	1.06	22	26.43	19.43
-17	1.37	1.16	23	28.09	20.58
-16	1.51	1.27	24	29.83	21.78
-15	1.65	1.39	25	31.67	23.05
-14	1.81	1.52	26	33.61	24.38
-13	1.98	1.65	27	35.65	25.78
-12	2.17	1.80	28	37.80	27.24
-11	2.38	1.96	29	40.06	28.78
-10	2.60	2.14	30	42.43	30.38
-9	2.84	2.33	31	44.93	32.07
-8	3.10	2.53	32	47.55	33.83
-7	3.38	2.75	33	50.31	35.68
-6	3.69	2.99	34	53.20	37.61
-5	4.02	3.25	35	56.24	39.63
-4	4.37	3.52	36	59.42	41.75
-3	4.76	3.82	37	62.76	43.96
-2	5.17	4.14	38	66.28	46.26
-1	5.62	4.48	39	69.93	48.67
0	6.11	4.85	40	73.78	51.19
1	6.57	5.19	41	77.80	53.82
2	7.06	5.56	42	82.02	58.56
3	7.58	5.95	43	86.42	59.41
4	8.13	6.36	44	91.03	62.39

Saturation pressure (p_s) and density (ρ_w) of saturated water vapor.

Gas	Volume %	Weight %
nitrogen N ₂	78.084	75.520
oxygen O ₂	20.947 6	23.142
argon Ar	0.934	1.288
carbon dioxide CO ₂	0.031 4	0.047 7
neon Ne	0.001 818	0.001 267
helium He	0.000 524	0.000 072 4
krypton Kr	0.000 114	0.000 330
xenon Xe	0.000 008 7	0.000 039
hydrogen H ₂	0.000 05	0.000 003
methane CH ₄	0.000 2	0.000 1
nitrous oxide N ₂ O	0.000 05	0.000 08
ozone O ₃	summer: 0 to 0.000 007	0 to 0.000 01

Composition of clean, dry air at sea level (remains relatively constant up to an altitude of 25 km).

Machine type and size	Air requirement max. l/s
Drilling machines, \varnothing = bit diameter (mm)	
Small $\varnothing < 6,5$	6.0
Medium $6,5 < \varnothing < 10$	7.5
Large $10 < \varnothing < 16$	16.5
Thread cutters	6
Screwdriver, d = screw size	
Small $d < M6$	5.5
Medium $M6 < d < M8$	7.5
Impact wrench, d = bolt size	
Small $d < M10$	5.0
Medium $M10 < d < M20$	7.5
Large $d \geq M20$	22.0
Filing machine	7.5
Polishers/Die grinders, e = power (kW)	
Small $e < 0,5$	8.0
Large $e > 0,5$	16.5
Grinders, e = power (kW)	
Small $0,4 < e < 1,0$	20.0
Medium $1,0 < e < 2$	40.0
Large $e > 2$	60.0
Chipping hammers	
Light	6.0
Heavy	13.5
Air hoists t = lifting tonnage	
$t < 1$ tonne	35
$t > 1$ tonne	45
Scaler	5.0
Cleaning nozzle	6.0
Nutrunner, d = bolt size	
$d \leq M8$	9
$d \geq M10$	19

Typical air consumption data of some common power tools and machines, based on experience. These values form the basis for calculating the requisite compressor capacity.

Dew point °C	g/m ³	Dew point °C	g/m ³	Dew point °C	g/m ³	Dew point °C	g/m ³
+100	588.208	+58	118.199	+16	13.531	-25	0.55
99	569.071	57	113.130	15	12.739	26	0.51
98	550.375	56	108.200	14	11.987	27	0.46
97	532.125	55	103.453	13	11.276	28	0.41
96	514.401	54	98.883	12	10.600	29	0.37
95	497.209	53	94.483	11	9.961	30	0.33
94	480.394	52	90.247	10	9.356	31	0.301
93	464.119	51	86.173	9	8.784	32	0.271
92	448.308	50	82.257	8	8.243	33	0.244
91	432.885	49	78.491	7	7.732	34	0.220
90	417.935	48	74.871	6	7.246	35	0.198
89	403.380	47	71.395	5	6.790	36	0.178
88	389.225	46	68.056	4	6.359	37	0.160
87	375.471	45	64.848	3	5.953	38	0.144
86	362.124	44	61.772	2	5.570	39	0.130
85	340.186	43	58.820	1	5.209	40	0.117
84	336.660	42	55.989	0	4.868	41	0.104
83	324.469	41	53.274			42	0.093
82	311.616	40	50.672	-1	4.487	43	0.083
81	301.186	39	48.181	2	4.135	44	0.075
80	290.017	38	45.593	3	3.889	45	0.067
79	279.278	37	43.508	4	3.513	46	0.060
78	268.806	36	41.322	5	3.238	47	0.054
77	258.827	35	39.286	6	2.984	48	0.048
76	248.840	34	37.229	7	2.751	49	0.043
75	239.351	33	35.317	8	2.537	50	0.038
74	230.142	32	33.490	9	2.339	51	0.034
73	221.212	31	31.744	10	2.156	52	0.030
72	212.648	30	30.078	11	1.96	53	0.027
71	204.286	29	28.488	12	1.80	54	0.024
70	196.213	28	26.970	13	1.65	55	0.021
69	188.429	27	25.524	14	1.51	56	0.019
68	180.855	26	24.143	15	1.38	57	0.017
67	173.575	25	22.830	16	1.27	58	0.015
66	166.507	24	21.578	17	1.15	59	0.013
65	159.654	23	20.386	18	1.05	60	0.011
64	153.103	22	19.252	19	0.96	65	0.0064
63	146.771	21	18.191	20	0.88	70	0.0033
62	140.659	20	17.148	21	0.80	75	0.0013
61	134.684	19	16.172	22	0.73	80	0.0006
60	129.020	18	15.246	23	0.66	85	0,00025
59	123.495	17	14.367	24	0.60	90	0.0001

Water content in the air at different dew points.

6.4 COMPILATION OF APPLICABLE STANDARDS AND REGULATIONS

6.4.1 General

In the compressed air sector, as in many other industrial sectors, regulations apply. They may include requirements that are defined by legislation as well as optional regulations or recommendations, as for national and international standards. Sometimes regulations in standards may become binding when they come into force through legislation. If a standard is quoted in a commercial agreement it can thereby also be made binding.

Binding regulations can apply, for example, to safety for people and property while optional standards are used to facilitate work with specifications, selection of quality, performing and reporting measurements, manufacturing drawings etc.

6.4.2 Standards

The benefits of international standardization are obvious to both manufacturers, intermediate parties such as engineering companies and final customers. It increases the interchangeability of products and systems, and allows performance statements to be compared on equal terms. These performance statements may include operational, environmental and safety aspects. Standards are referred to frequently by legislators as a way of creating uniform market impacts. Standards may be produced, issued and maintained by standardization organizations on national, supra-national (European) and international levels, but equally by specific trade associations focusing on specific industrial sectors (the petroleum industry, compressed air industry, electronics industry etc).

Standards produced by the International Organization for Standardization (ISO) may be converted into national standards by the ISO member countries at their discretion. Standards produced by the CEN (European Committee for Standard-

ization), are developed for use by the 30 national members, and conversion into national standard may be mandatory in the case of harmonized standards. All standards can be acquired through the various national standardization organizations.

In the compressed air industry, standards may also be produced by trade associations such as PNEUROP (European committee of manufacturers of compressed air equipment, vacuum pumps, pneumatic tools and allied equipment), or its counterpart CAGI (United States Compressed Air and Gas Institute). Examples of such documents are the performance measurement standards for compressor capacity, oil content in the compressed air, etc. which were issued while awaiting an international standard to be developed.

6.4.3 Compilation

A non-exhaustive list of current (2010) standards within the compressed air industry follows below. The listed references are both European and US. Pneurop standard initiatives are usually issued in parallel with a CAGI issue for the American market.

It is recommended to check with the issuing body to ensure that the latest edition is being used, unless the particular market requirement/demand refers to a dated issue.

6.4.3.1 Machinery safety

EU Machinery directive 2006/42/EC, referring to the following standards:

EN 1012-1 Compressors and vacuum pumps – Safety requirements

EN ISO 12100-1:2003 AMD 1 2009, Safety of Machinery – Basic concepts, General principles for design – Part 1: Basic Terminology, Methodology

EN ISO 12100-2:2003 AMD 1 2009, Safety of Machinery – Basic concepts, General principles for design – Part 2: Technical Principles

6.4.3.2 Pressure equipment safety

EU Directive 87/404/EC, Simple pressure vessels

EU Directive 97/23/EC, Pressure Equipment, referring to the following standards:

EN 764-1 to 7, Pressure equipment

EN 286-1 to 4, Simple, unfired pressure vessels designed to contain air or nitrogen

6.4.3.3 Environment

EU Directive 2000/14/EC, Outdoor Noise Emission, referring to the following standards:

EN ISO 3744:2009, Determination of sound power levels of noise sources using sound pressure – Engineering method

EN ISO 2151:2004, Noise test code for compressors and vacuum pumps – Engineering method

EU Directive 2004/26/EC, Emission standard for non-road engines – Stage III levels implemented from 2006 to 2013, Stage IV as from 2014

US Federal Emission standard for non-road engines – Tier III levels implemented from 2006 to 2008, Tier IV levels as from 2008 to 2015

6.4.3.4 Electrical safety

EU Directive 2004/108/EC, Electromagnetic compatibility, referring to the following standards:

EN 61000-6-2:2005, Electromagnetic compatibility (EMC) - PART 6-2: Generic Standards - Immunity for Industrial Environments

EN 61000-6-4:2006, Electromagnetic compatibility (EMC) - PART 6-4: Generic Standards – Emission standards for Industrial Environments

EU Directive 2006/95/EC, Low Voltage Equipment, referring to following standards:

EN 60034- Part 1 to 30, Rotating Electrical Machines – Rating and Performance

EN 60204-1:2009, Safety of Machinery - Electrical Equipment of Machines – Part 1: General Requirements

EN 60439-1:2004, Low-voltage switchgear and control gear assemblies – Part 1: Type tested and partially type tested assemblies

6.4.3.5 Medical devices – general

EU Directive 93/42/EC, referring to the following standards:

EN ISO 13485:2000, Plastics Piping system – Test method for leak-tightness under internal pressure

EN ISO 14971:2007, Medical Devices – Application of risk management to Medical Devices

6.4.3.6 Standardization

ISO 3857-1:1977, Compressors, pneumatic tools and machines - Vocabulary - Part 1: General

ISO 3857-2:1977, Compressors, pneumatic tools and machines - Vocabulary - Part 2: Compressors

ISO 5390:1977, Compressors - Classification

6.4.3.7 Specifications and testing

ISO 1217:2009, Displacement compressors – Acceptance tests

ISO 5389:2005, Turbo-compressors - Performance test code

ISO 7183:2007, Compressed air dryers - Specifications and testing

ISO 12500:2007-Part 1 to 3, Filters for Compressed Air – Test Methods

ISO 8573-Part 1 to 9, Compressed Air - Contaminants and purity classes – Test Methods

INDEX

A	
absolute pressure	1.2.1
absolute zero	1.2.2
absorption	2.4.1
absorption dryers	2.4.1.4
activated carbon	3.2.9
active power	1.6.4
adsorption	2.4.1
adsorption dryers	2.4.1.5
after cooler	2.4.1.1, 3.2.6
air	1.4
air-borne energy recovery	3.4.3.2
air composition	1.4.1
air consumption	1.1.2, 4.2.3
air cooled compressor	3.3.2
air receiver	3.6.1.1
air requirement	3.1.1.2
air treatment	3.2
alternating current	1.6.1
apparent power	1.6.4
atmospheric pressure	1.2.1
atomic number	1.1.1
axial compressors	2.2.3
B	
booster compressors	2.3.2
Boyle's law	1.3.2
bypass regulation	2.5.2.2
C	
cables	3.7.6
capacitive measurement system	2.5.5.2
carbon filter	2.4.2, 3.2.5
Celsius scale	1.2.2
central control	2.5.7
centralized installation	3.1.2.2
centrifugal compressors	2.2.2
changes in state	1.3.4
Charles' law	1.3.2
circuit-breaker	3.7.5
clearance volume	1.5.3
closed cooling system	3.3.1.4
compressed air central	3.5.1, 3.5.2, 3.5.3
compressed air distribution	3.6.1
compressed air quality	3.2.2
compression in several stages	1.5.5
compressor calculation	4.3.2
compressor central	3.1.2, 3.5
compressor package	3.5.1
conductivity	1.3.3
contactor	3.7.3
continuous capacity regulation	2.5.1
control and monitoring	2.5.4
convection	1.3.3
cooling methods	1.6.5.5, 3.3
cost allocation	4.1.1.1, 4.3.2
critical pressure ratio	1.3.5.
D	
data monitoring	2.5.5
decentralized installations	3.1.2.3
decibel	3.8.1
degree of recovery	3.4.2, 4.2.6
delta connection	1.6.5.7.
dew point	1.4.2
diaphragm compressors	2.1.4
diaphragm filter	3.2.8
dimensioning	3.1.3, 3.1.5.1
direct start	3.7.3
displacement compressors	1.5.2, 2.1.1
double acting compressors	1.5.2, 2.1.2
drawing symbols	6.2
drying	2.4.1
dynamic compressors	1.5.4., 2.2.1
E	
electric motor	1.6.5
electrical current	1.6.1
electrical voltage	1.6.1
electricity	1.6
electromotive force (emf)	1.6.2
electrons	1.1.1
energy recovery	3.4
equivalent pipe length	3.6.3
exhaust emissions	2.6.2
F	
FAD	1.2.6
filter	2.4.2, 3.2.5
filter efficiency	2.4.2
flow through pipes	1.3.6
frequency	1.6.1
frequency converter	2.5.4.3
fuses	3.7.5

G

gas constant	1.3.2
gas laws	1.3.2
gradual start	3.7.3

H

heat exchanger	5.7.1, 5.7
heat transfer	1.3.3
high pressure compressor	3.6.1.1
high voltage	1.6.1

I

idling time	2.5.4.2
impedance	1.6.2
individual gas constant	1.3.2
inlet regulation	2.5.3.1
installation's overall economy	4.1.1.1
insulation class	1.6.5.3
intake air	3.5.4
intake pressure variation	3.1.3.2
isentropic process	1.3.4.4
ISO	6.4
isobaric process	1.3.4.2
isochoric process	1.3.4.1
isothermal process	1.3.4.3

J

Joule-Thomson effect	1.3.7
----------------------	-------

K

Kelvin scale	1.2.2
--------------	-------

L

laminar flow	1.3.6
leakage	3.1.1.3, 4.2.3
life cycle cost, LCC	4.3
liquid injected screw compressors	2.1.5.2
loading	2.5.1
logarithmic mean temperature difference	1.3.3
low voltage	1.6.1

M

main voltage	1.6.3
maintenance costs	4.2.7
maintenance planning	4.2.7.1
MD dryer	2.4.1.5
medical air	3.2.9
membrane dryers	2.4.1.6
metal resistor	2.5..1

micro-organisms	3.2.4
mobile compressors	2.6
modulation	2.5.3.4
moist air	1.4.2
molecular movement	1.1.2
molecules	1.1.1
monitoring	2.5.5.3, 2.5.8
multi-stage off loading	2.5.2.8

N

neutrons	1.1.1
new investment	4.1.1.1
noise	3.8.9
non-sinusoidal waveforms	1.6.1
normal litre	1.2.6
nozzle	1.3.5

O

off loading/loading	2.5.1
Ohm's law	1.6.2
oil filter	3.2.5
oil-free compressors	2.1.3
oil-free screw compressors	2.1.5.1
oil temperature control	2.6.3
oil/water separation	3.2.8
open cooling system	3.3.1.2, 3.3.1.3
operating analysis	3.1.1.3
operating costs	4.1.1.1, 4.1.1.2
optimised compressor operations	4.1.1.1
outlet regulation	2.5.3.2
over compression	2.4.1.3
overall cost	4.3.2
overload protection	3.7.5

P

part flow measurement	3.6.4
particle filter	2.4.2
phase compensation	3.7.7
phase displacement	1.6.2
phase voltage	1.6.3
pipe resonance	3.5.4
pipes	1.3.3
piston compressors	1.5.1, 1.5.2, 2.1.2
plasma	1.1.2
polytropic process	1.3.4.5
power	1.2.5, 1.6.4.
Power Factor	1.6.4
prefilter	3.5.4
pressure	1.2.1
pressure intensifier	2.3.3

pressure band	2.5.4.2
pressure dew point	2.4.1
pressure drop	1.3.6, 4.2.2
pressure measurement	1.2.1, 2.5.5.2
pressure ratio	1.5.2
pressure relief	2.5.2.1, 2.5.3.4
pressure relief with throttled intake	2.5.2.4
pressure switch	2.5.4.2
protection classes	1.6.5.4
protons	1.1.1

Q

quality class in accordance with ISO	3.2.2
quantity of ventilation air	3.5.5

R

radial compressors	2.1.1, 2.2.2
radiation	1.1.1
reactance	1.6.2
reactive power	1.6.4
recovery potential	3.4.2, 4.2.6
refrigerant dryer	2.4.1.2
regulation	2.5.1
regulation system	2.5.1
remote monitoring	2.5.8
resistance	1.6.2
resistance thermometer	2.5.5.1
resistive measurement system	2.5.5.2
reverberation	3.8.4
Reynolds' number	1.3.6
ring piping	3.6.2
room constant	3.8.3
roots blowers	2.1.9

S

saving possibilities	4.2
screw compressors	2.15
scroll compressors	2.1.7
separation efficiency	2.4.2
sequence control	2.5.6.1
short-circuit protection	3.7.5
single acting compressor	1.5.2, 2.1.2
SI-system	6.1
sound	3.8
sound absorption	3.8.8
sound dampening	3.8.8
sound measurements	3.8.6
sound power level	3.8.1
sound pressure level	3.8.1

speed regulation	2.5.2.6, 2.5.4.3
standards	6.4
star connection	1.6.3, 1.6.5.7
star/delta start	3.7.3
start sequence selector	2.5.6.1
start/stop regulation	2.5.2.5
starter	3.7.3, 3.7.5
sterile filters	3.2.5
stroke volume	1.5.3
suction valve unloading	2.5.2.8
synchronous speed	1.6.5.1

T

tables	6.3
temperature	1.2.2
temperature measurement	2.5.5.1
thermal capacity	1.2.3
thermal conductivity number	1.3.3
thermistor	2.5.5.1
thermodynamics	1.3
three phase system	1.6.3
throttling	1.3.7
throttling the inlet	2.5.2.3
tooth compressor	2.1.6
torque	1.6.5.8
turbo compressor	2.2.1
turbulent flow	1.3.6
twin screw compressors	2.1.5
types of compressors	1.5

V

vacuum pumps	2.3.1
valve off-loading	2.5.2.8
vane compressors	2.1.8
vane regulation	2.5.3.2, 2.5.3.3
variable discharge port	2.5.2.7
ventilation fan	3.5.5
volume rate of low	1.2.6

W

water content in compressed air	2.4.1, 3.2.2
water cooled compressor	3.3.1
water separator	2.4.1.1
water vapor	3.2.2
water-borne energy recovery	3.4.3.3
work	1.2.4
working pressure	3.1.1.1

NOTES

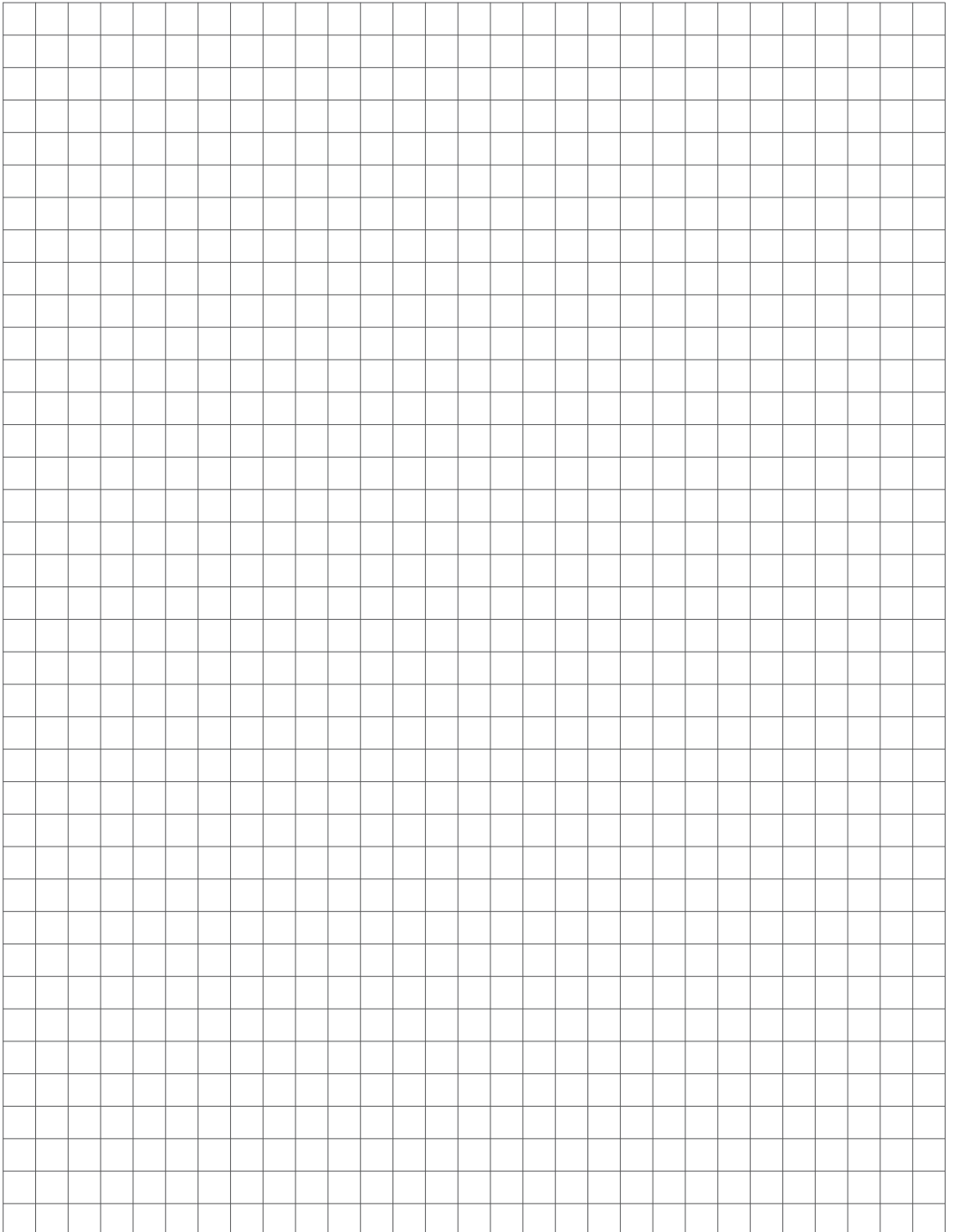



Atlas Copco Airpower NV
Boomsesteenweg 957
B-2610 Wilrijk
Belgium
www.atlascopco.com

